

ESO

European Organisation
for Astronomical
Research in the
Southern Hemisphere

Annual Report 2017



ESO

European Organisation
for Astronomical
Research in the
Southern Hemisphere

Annual Report 2017

Presented to the Council
by the Director General
Xavier Barcons

The European Southern Observatory

ESO, the European Southern Observatory, is the foremost intergovernmental astronomy organisation in Europe. It has 15 Member States: Austria, Belgium, the Czech Republic, Denmark, France, Finland, Germany, Italy, the Netherlands, Poland, Portugal, Spain, Sweden, Switzerland and the United Kingdom. Several other countries have expressed an interest in membership.

Created in 1962, ESO carries out an ambitious programme focused on the design, construction and operation of powerful ground-based observing facilities enabling astronomers to make important scientific discoveries. ESO also plays a leading role in promoting and organising cooperation in astronomical research.

ESO operates three world-class observing sites in the Atacama Desert region of Chile: La Silla, Paranal and Chajnantor. La Silla, located 2400 metres above sea level and 600 kilometres north of Santiago de Chile, was ESO's first site. It is equipped with several optical telescopes with mirror diameters of up to 3.6 metres.

The 3.58-metre New Technology Telescope (NTT) broke new ground in the 1980s and was the first in the world to have a computer-controlled main mirror, a technology developed at ESO and now applied to most of the world's current large telescopes. La Silla remains at the forefront of astronomy, and is the second most scientifically productive observatory in ground-based astronomy (after Paranal). The Paranal site is located 2600 metres above sea level and is home to the Very Large Telescope (VLT), the Visible and Infrared Survey Telescope for Astronomy (VISTA), the world's largest survey telescope, and the VLT Survey Telescope (VST), the largest telescope designed exclusively to survey the skies in visible light. Paranal is situated about 130 kilometres south of Antofagasta in Chile, 12 kilometres inland from the Pacific coast in one of the driest areas in the world. Scientific operations began in 1999 and have resulted in many extremely successful research programmes.

The VLT is a unique facility and arguably the world's most advanced optical instrument. It is not just one telescope, but an



ESO/Gregory Lambert

array of four, each with a main mirror 8.2 metres in diameter. With one such telescope, images of celestial objects as faint as magnitude 30 have been obtained in a one-hour exposure. This corresponds to seeing objects that are four billion times fainter than those seen with the naked eye.

One of the most exciting features of the VLT is the option to use it as a giant optical interferometer (the VLT Interferometer

Four lasers being used to correct for atmospheric distortion at the VLT in Paranal.

or VLTI). This is done by combining the light from two or more of the 8.2-metre Unit Telescopes (UTs) or two or more of the four 1.8-metre movable Auxiliary Telescopes (ATs). In this interferometric mode, the telescope's vision is as sharp

ESO's La Silla site hosts a large number of telescopes, which are shown here.



ESO/A. Tudorică



ALMA antennas observing the sky at millimetre and submillimetre wavelengths.

as that of a telescope the size of the separation between the most distant mirrors. For the VLTI, this is up to 200 metres.

The Atacama Large Millimeter/submillimetre Array (ALMA), the largest ground-based astronomy project in existence, is a revolutionary facility for world astronomy. ALMA comprises an array of 66 antennas of 12 and 7 metres in diameter observing at millimetre and submillimetre wavelengths. It is located on the high-altitude Chajnantor plateau, 5000 metres above sea level — one of the highest astronomical observatories in the world. The ALMA project is a partnership between ESO, East Asia and North America, in cooperation with the Republic of Chile.

The Chajnantor site is also home to the Atacama Pathfinder Experiment (APEX), a 12-metre diameter millimetre and submillimetre telescope, operated by ESO on behalf of the Max Planck Institute for Radio Astronomy, the Onsala Space Observatory and ESO itself.

Each year, about 1800 proposals are submitted for the use of ESO telescopes, requesting between three and six times as many nights as are available. In addition, astronomers from the regions repre-

sented by ESO submit around 750 proposals to ALMA every year. ESO is the most productive ground-based observatory in the world, whose operation yields many peer-reviewed publications: in 2017 alone 1085 refereed papers based on ESO data were published.

The next step beyond the VLT is the construction of the Extremely Large Telescope (ELT) with a primary mirror 39 metres in diameter. ESO's ELT will be "the world's

biggest eye on the sky" — the largest optical/near-infrared telescope in the world. On completion, it will address many of the most pressing unsolved questions in astronomy and may, eventually, revolutionise our perception of the Universe, much as Galileo's telescope did 400 years ago. Construction is ongoing at Cerro Armazones near Paranal, and most major contracts have been signed. The start of ELT operations is expected in 2026.

The ESO Headquarters are located in Garching, near Munich, Germany. This is the scientific, technical and administrative centre of ESO where technical development programmes are carried out to provide the observatories with the most advanced instruments. ESO's offices in Chile are located in Vitacura, Santiago. They host the local administration and support groups, and are home to ESO/Chile astronomers when they are not at the observatories. This site also contains the ALMA Santiago Central Office. ESO Vitacura is an active node for training new generations of researchers, acting as a bridge between scientists in Europe and Chile.

The total regular Member State contributions to ESO in 2017 were approximately 165 million euros and ESO employs around 695 staff.

Artist's rendering of the ELT in operation.



Contents

Foreword by the President of Council	6
Introduction by the Director General	7
Science	10
Research Highlights	11
Offices for Science	20
Allocation of Telescope Time	24
Publication Digest	27
Education and Outreach	31
Operations	38
La Silla Paranal Observatory	39
Data Management and Operations	48
ALMA	53
Programmes	60
Instrumentation for the La Silla Paranal Observatory	61
Technology Development	67
The Extremely Large Telescope	70
Engineering	76
Administration	86
Finance and Budget	88
Human Resources	92
Organigram	96
Office of the Director General	98
Organisational Matters	106
Council	107
Finance Committee	108
Scientific Technical Committee	109
Observing Programmes Committee	111
Users Committee	113
International Staff Association	114
Local Staff Representatives	115
Diversity	116
Calendar of Events	118
Glossary of Acronyms	122

Foreword by the President of Council

The Annual Report always provides an occasion to reflect on the past year. As I began to collect my thoughts, I was quickly overwhelmed by the growing list of important items that should be mentioned. A year at ESO is always incredibly busy and 2017 was no exception.

Scientific and technical achievements in key areas were numerous. The present report highlights the incredible progress achieved over essentially the entire spectrum of ESO programmes and activities. Of course, this does not mean that there are no challenges ahead, but rather that ESO is in the best possible position to overcome them. A few landmark decisions by the ESO Council have led to major changes in the Organisation and its programmes — additional elements that are key to securing this position and preparing for the future.

During 2017, the ESO Council met four times, twice at Headquarters in Garching (June and December) and twice as the Committee of Council in Prague (March) and in Paris (October). The hospitality of the respective delegations and ministries was greatly appreciated and allowed for constructive discussions that later enabled key decisions.

In a milestone decision in December, Council unanimously approved the first spending on Phase 2 of ESO's ELT, with the purpose of completing the inner five rings, the seventh sector of the primary mirror and the second coating unit. This bold decision removes lingering uncertainties for the project as well as for the instrument teams. Even more importantly, the ELT project once again includes its full-sized mirror and nominal capabilities at first light, still planned for 2024. A major milestone indeed.

Earlier during the summer, ESO entered a ten-year strategic partnership with Australia. In a ceremony held at the Australian National University in Canberra, the Australian Minister for Industry, Innovation, and Science, Arthur Sinodinos and the ESO Director General, Tim de Zeeuw signed the arrangement. At a time when all second-generation Very Large Telescope (VLT) and VLT Interferometer (VLTI) instruments have been delivered to

Paranal, this partnership provides new opportunities to bring together expertise within the ESO and Australian communities to further exploit and expand the world-class instrumentation available at ESO. As most of the attention necessarily turns towards the construction of ESO's ELT, this bodes well for astronomers for whom the VLT, the VLTI, the survey telescopes (VISTA and the VST), and the La Silla telescopes (the ESO 3.6-metre and the NTT), together with ALMA, will serve as the workhorse facilities for the years to come.

In April 2017, ESO handed over the new Residencia at the ALMA Operation Support Facility. This was the last major construction item to be delivered under ESO's contributions to the successful ALMA project. Home to the staff and to people working temporarily at the site, the Residencia provides a very welcome change from the previously available temporary facilities, helping to ease daily life in the harsh environment of Northern Chile.

On 31 August, Council and the Organisation said farewell to Tim de Zeeuw, Director General of ESO for the last decade. The extraordinary changes and achievements delivered by the Organisation under Tim's leadership were highlighted by several distinguished speakers during an outstanding special conference held at ESO Headquarters in Garching at the end of August. Reminiscing over the past decade really brought home how mature ESO has become and how confidently it can assume its role as a world-leading astronomical institution.

While the Director General plays a central role, the management, the staff, and the members of Council and committees deserve equal recognition, for without them there would be no Organisation. I would like to express Council's deep gratitude for their work and dedication, including to all who left the Organisation during 2017 and to the family and friends of those who passed away. Together, you have contributed in no small measure to making ESO what it is today.

Tim de Zeeuw's successor, Xavier Barcons, was appointed as the new

Director General by Council, and started in his role on 1 September 2017. As a not-so-distant former President of the ESO Council, Xavier Barcons has stepped into his new shoes with amazing ease and has taken rapid ownership of the Organisation. Council is looking forward to working constructively with him, with the ESO management and with all the staff in Europe and Chile in the years to come.

Finally, I would like to express my deep thanks and gratitude to Patrick Roche who finished his term as President of Council in 2017. Over the last three years, his dedication, expert leadership, and patience have not only allowed Council to come to essential decisions despite a tight financial environment and challenging situations, but have also served ESO well on the global astronomical scene. Thank you very much Pat!



Willy Benz
President of Council

Introduction by the Director General

2017 marked a year full of achievements for ESO, building on its 55 years of history. A very clear marker of this success is in the more than 1000 scientific papers that were published during 2017 using data obtained from the many ESO facilities. This is a cause for celebration with the scientific community, with the partnerships through which our instruments are developed, with industry, and with the governments of our Member States and the host country, Chile. All of these new science results are interesting and a few of them even made headlines in the media. Three prominent examples include the discovery of potentially habitable Earth-like planets around the star TRAPPIST-1, the identification of the gravitational wave event GW170817 produced by the coalescence of two neutron stars, and the characterisation of the interstellar visitor to our Solar System, 'Oumuamua. These examples underline two increasingly important factors when it comes to making transformational discoveries in astronomy: worldwide scientific collaborations and the use of multiple facilities.

Support from ESO's 15 Member States and the Republic of Chile was at full strength over the course of the year. In July, they were joined by Australia as a partner in ESO's La Silla Paranal Observatory programme for the next 10 years. In October, Ireland announced its intention to join ESO and negotiations are underway. ESO's standing in the European Research Area has continued through excellent links with other EIROForum organisations and the European Commission, among other stakeholders.

In full compliance with its mission, ESO has made good progress with the construction and operation of its world-class facilities. The lively and highly productive La Silla site continues to attract and host new telescope projects from many partners and continues the efficient operation of two facility telescopes, the planet-hunting ESO 3.6-metre telescope and the 3.58-metre NTT, which is primarily used for follow-up observations of transient events. At Paranal, the VLT, the VLTI and the survey telescopes, VST and VISTA, have maintained their highly efficient and reliable operation, enabling ESO to keep its position at the forefront of optical ground-based astronomy

around the world. A major milestone was achieved in December, when Paranal was fully connected to the Chilean power grid, enhancing ESO's environmental protection policy.

The conversion of the Unit Telescope 4 (UT4) of the VLT into a fully adaptive optics telescope, a precursor of the ELT, made big advances and the Laser Guide Star Facility (LGSF) is now in regular use. The Echelle SPectrograph for Rocky Exoplanet and Stable Spectroscopic Observations (ESPRESSO), the ultra-stable spectrometer capable of adding the light from the four VLT Unit Telescopes, saw first light in November. The VLTI instrument Multi-Aperture mid-Infrared Spectroscopic Experiment (MATISSE) was shipped to Chile in October, on track for first light in early 2018. The adaptive optics assisted, two-object, multiple beam-combiner GRAVITY, also on the VLTI, began its commissioning, along with a time-critical campaign to observe the Galactic Centre. The APEX project was extended for a period of five years, and, after a telescope overhaul, it will resume science operations during the first half of 2018.

ESO delivered the ALMA Residencia, which houses its personnel at the site, resulting in a substantial improvement in the living conditions. ESO also completed the delivery of the Band 5 receivers for ALMA, in a joint effort with European institutes and our international ALMA partners. European astronomers led almost half of the scientific publications resulting from ALMA observations showing the very strong impact of this facility on European astronomy. The unique millimetre/submillimetre facility that is ALMA progressed towards steady-state operations in 2017. Unusually extreme weather conditions prevented the completion of some observations, but the science produced by the ALMA observatory was truly breathtaking.

ESO's most challenging project ever, the ELT, shot through several new milestones. Contracts amounting to about 90% of the value of the construction have already been authorised by the Finance Committee and placed. After the ELT First Stone ceremony on 26 May, in the presence of the President of Chile,



ESO/M. Zamani

Michelle Bachelet, the Armazones site was handed over to the ELT Dome and Main Structure contractor. Preparations are well advanced and construction work at the site began in early 2018. Most of the contracts for optomechanics are also running, as well as those for many other components. First-light instruments are beginning to pass their Preliminary Design Reviews (PDRs). In December, in a visionary decision, Council authorised the construction of the full ELT 39-metre diameter primary mirror.

The impressive milestones achieved by ESO in its various programmes were the result of the hard work and continued commitment of our talented personnel. There are so many activities happening behind the scenes, in our laboratories, infrastructures, workshops, offices, meeting rooms, review boards, and even in discussions during coffee breaks, that it would be impossible to list them all. We do see the outcome of this massive effort in, for example, new instruments at Paranal, new discoveries with ALMA, the first batch of ELT segments being cast, and the low technical downtime at the La Silla Paranal Observatory (LPO). Collaborative work, only small parts of which are visible from the outside, is behind all of ESO's successes.

ESO is facing perhaps its most significant challenge with the construction of the ELT, while keeping the LPO and ALMA at the forefront of astronomy worldwide. Fostering cooperation in astronomy is also part of ESO's mission, through science and outreach activities, training of students and fellows, and also by actively working towards hosting and operating the southern part of the Cherenkov Telescope Array (CTA) at Paranal.

I am fully convinced that ESO will succeed in meeting this decade-long challenge that began a few years ago on the basis of two pillars. The first, the support of our Member States and partners, whose importance we acknowledge by ensuring that their delegations are fully and transparently appraised of ESO's activities. The second, the engagement and enthusiasm of our ESO staff, which we need to maintain by implementing measures that help to preserve work-life balance. Securing both of these pillars is the best — and possibly the only — recipe for achieving success.

Most of the achievements reported here were directly or indirectly brought about by my predecessor Tim de Zeeuw, who served as ESO Director General for 10 years. His vision and dedication truly took ESO to new heights and I want to thank him for this as well as for a very smooth handover.

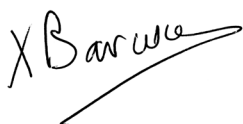

Xavier Barcons
ESO Director General

A collage bringing together all of ESO's facilities into a single imaginary landscape.





Science



Research Highlights

The Directorate for Science (DSC) maintains a close relationship with members of the scientific community in the ESO Member States to ensure that ESO can best serve their needs. The DSC contains ESO's Project Scientists, its ALMA, VLT, VLTI and ELT Programme Scientists, the Observing Programmes Office (OPO) team, who organise the allocation of time on ESO's telescopes, the education and Public Outreach Department (ePOD), whose staff communicate the excitement of ESO's astronomy to the public, and of course, ESO's wonderfully talented fellows and students.

Most astronomers at ESO in fact fall under the Directorate of Operations, with some others distributed across the other directorates. The Office for Science in the directorate, which includes the forward-looking librarians, exists to provide a healthy, vibrant environment in which all of ESO's scientists, as well as the many distinguished scientific visitors from the local campus and beyond, can flourish.

In 2017, the DSC experienced a considerably larger number of staff movements than usual. Gaitee Hussain left OPO to join the Office of the Director General; Jason Spyromilio re-joined the ELT Programme as Telescope Scientist; Richard Ellis moved to University College London after two years as Senior Visiting Scientist; Leonardo Testi was promoted to Division Head of the ESO ALMA Support Centre after a decade as ALMA Programme Scientist; and last but definitely not least, Pam Bristow retired after 35 years of service as Administrative Assistant. Heading in the other direction, Antoine Mérand, Dimitri Gadotti, Mariya Lyubenova, Glenn van de Ven, Nelma Silva and Mylène André were all welcomed to the DSC.

VLT image of the face-on spiral galaxy Messier 77 (NGC 1068).

There was some very exciting science news in 2017, reporting unique and unprecedented events. ESO facilities contributed to these with some truly stunning observations. The selected highlights outlined here demonstrate the continued success of ESO telescopes and operations. Some observations relied on the large instrument complement offered by ESO's facilities and the operational ability of the observatories to adapt to unexpected events and collect the best possible data, sometimes at extremely short notice. As well as progress in a number of astrophysical fields, there were some amazing discoveries in 2017: the first detection of an interstellar traveller passing through the Solar System; the discovery of an electromagnetic counterpart to a gravitational wave source; and

a rich planetary system found around a nearby star.

On the VLTI, the adaptive optics assisted, two-object, multiple beam-combiner GRAVITY is probing the Galactic Centre in unprecedented detail. ALMA observations of the environments of young solar-type stars have yielded detections of molecules that have also been found on comets in the Solar System. Observations of lensed submillimetre galaxies reveal the properties of gas in their environments. Stunning ALMA images of evolved stars will enable scientists to understand mass loss in these objects. Finally, in 2017 ALMA gained the capability to observe the Sun, which will enable physicists to study the solar chromosphere and heating in the outer layers of the solar atmosphere.

An interstellar visitor to the Solar System

For the first time, an object wandering into the Solar System from afar has been observed on its way around the Sun. It was discovered in Hawaii during a wide-field survey project called the Panoramic Survey Telescope And Rapid Response System (PanSTARRS) as it was moving past the Earth after passing the Sun. Measurements of its hyperbolic orbit showed that this object was an interstellar traveller passing through the Solar System. This led the International Astronomical Union (IAU) to introduce a new designation, "interstellar asteroids", and the name 1I/2017 U1 for this object. The astro-

nomers who discovered it refer to it by the Hawaiian name 'Oumuamua, which means "scout" or "messenger". Many telescopes followed this Solar System intruder for as long as possible. VLT observations contributed to establishing its very peculiar light curve, which indicated that the shape of 1I/2017 U1 was elongated, apparently several times longer than wide and appearing more like a slab. Detailed imaging allowed the observers to deduce that there was no extended halo resulting from cometary activity like outgassing. This implies that there are no volatiles within 1I/2017 U1 — hence its

ESO/K. Meusch et al.

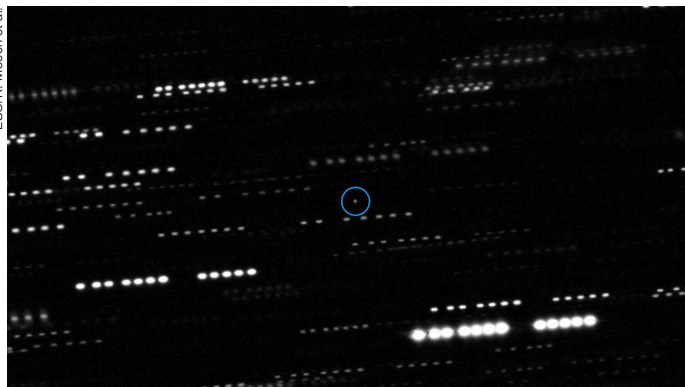

Image of 'Oumuamua based on observations from multiple telescopes including the VLT. The asteroid is the point source at the centre of the blue circle and is surrounded by trails of faint stars (caused by tracking the fast-moving asteroid). An artist's impression of the object is shown on p. 30.

designation as an asteroid. The light curve, with a period of about 7 hours and 20 minutes, shows that the object is probably tumbling, i.e., rotating about its shortest axis; this requires that it have some tensile strength in order to maintain its shape. Photometry with the Focal Reducer and low dispersion Spectrograph 2 (FOR2) and spectroscopy from

the wideband ultraviolet-infrared spectrograph X-shooter indicated that the object was quite red, corresponding to D-type asteroids or objects found in the outer Solar System.

Such objects typically have very low albedos (about 4%), and the observations indicate an extension of about 400 m.

Its colour is consistent with material that was originally organic-rich and which has undergone exposure to cosmic rays. A mantle treated in this manner could still be covered in organic ices, but data from X-shooter indicated that there was no ice within the top 40 cm of the mantle of 11/2017 U1.

Discovery of an electromagnetic counterpart to a gravitational wave source

Ripples in space due to gravitational waves were detected for the first time in 2016 (earning the 2017 Nobel Prize in Physics). However, the electromagnetic counterpart could not be identified. This changed on 17 August 2017, when an optical transient object was found to be co-located with a gravitational wave event and a gamma-ray burst. For the

first time, the information from gravitational waves (essentially describing the merging event) and from the electromagnetic spectrum (describing the aftermath of the merger) could be combined to obtain a fuller picture of one such event.

The existence of binary systems composed of two neutron stars has been known for some time from their radio emission. Theorists had hypothesised that the merger of two neutron stars caused by the loss of angular momentum through emission of gravitational waves would produce short gamma-ray bursts and could be responsible for the formation of elements beyond the iron group in the periodic table.

Detailed observations across the electromagnetic spectrum of the gravitational wave event GW170817 confirmed several of the predictions. A coincident gamma-ray burst source (called GRB 170817A) was found by the NASA/Fermi and ESA/INTEGRAL satellites within two seconds of the gravitational wave event. The optical counterpart to GW170817 was called AT2017gfo and was discovered in the galaxy NGC 4993 within 11 hours of the detection by the Laser Interferometer Gravitational-Wave Observatory (LIGO) and the Virgo collaboration.

ESO observations contributed to the optical and near-infrared picture of GW170817. In particular, the X-shooter

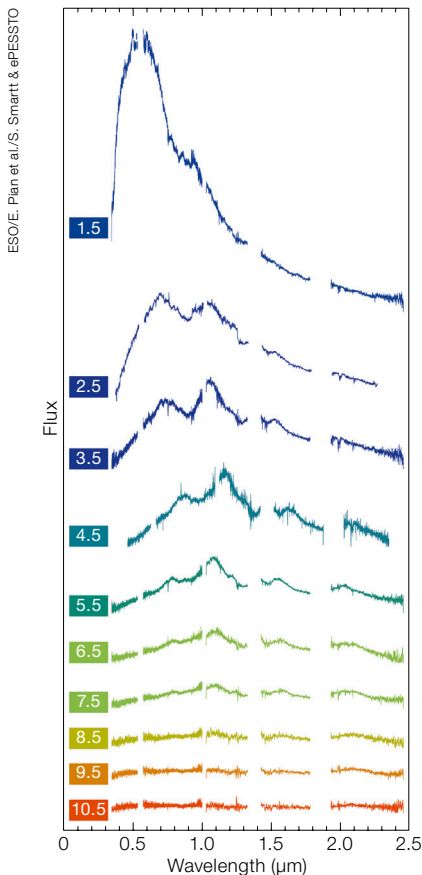

Left: Montage of X-shooter spectra showing the evolution of the kilonova associated with the gravitational wave source GW170817 over a period of 10.5 days after the gravitational wave was detected. Each spectrum covers a range of wavelengths from the near-ultraviolet to the near-infrared and reveals how the object became dramatically redder as it faded.

Right: Lightcurves showing the different behaviour of the kilonova associated with GW170817 at optical (0.66 μm) and infrared (2.15 μm) wavelengths; showing how it changed colour from blue to red over four weeks.

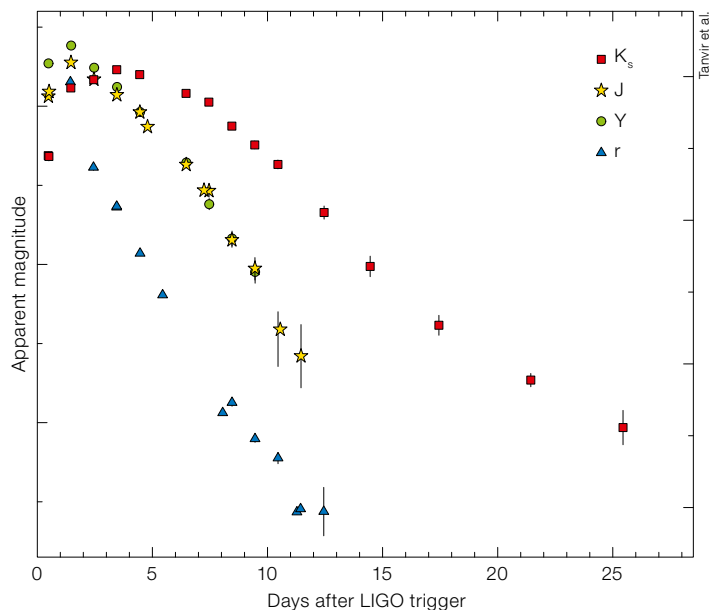

spectral series and the optical/infrared light curves sampled the event in unprecedented detail. Even though the electromagnetic emission could be observed for less than two weeks at optical wavelengths, a detailed record could be collected. The kilonova, as the electromagnetic counterpart is called, could be observed for longer in the near-infrared as the material cools very quickly in the rapidly expanding explosion. VISTA was able to follow the infrared light curve for nearly four weeks after the event.

The ESO observations provide strong evidence that heavy elements were produced in this merger. An outstanding major puzzle in astrophysics concerns the synthesis of elements heavier than iron. Their nuclei typically have many more neutrons than protons and so they must form in a neutron-rich environment. Since free neutrons are unstable and decay with a half-life of about 15 minutes there are not many “natural” places where the nucleosynthesis of heavy nuclei can proceed. During the merger of two neutron

stars, many neutrons are released and the formation of heavy elements may proceed rapidly. The spectra of GW170817 are in broad agreement with the predictions of simulations of the merger of two neutron stars and have been taken as proof that most heavy elements are formed in such mergers. This is a very important result as it has a direct bearing on how life can evolve in certain parts of our Universe.

Progress on exoplanet exploration

Following the discovery of a planet orbiting the nearest star to the Sun in 2016, the exoplanet community added many more interesting systems to the steadily growing list of planets around other stars. A major addition was the planetary system around a low-mass star (about 8% of the mass of the Sun and at the distance of some 35 light-years or 10.7 parsecs) with seven planets. The system, known as TRAPPIST-1, was discovered by the TRAnsiting Planets and Planetesimals Small Telescope (TRAPPIST) of the University of Liège, which is hosted on La Silla. The masses of the planets range from about a third of an Earth mass to 1.5 Earth masses and they have orbital periods ranging from 1.5 to nearly 19 days. Several of the planets are at distances from the star that would allow water to exist in the three aggregate states (ice, water and vapour) simultaneously. This is thought to be a critical condition for the emergence of life.

The planets are also distributed in a resonant chain, which means that their orbital ratios are integer numbers (for example, Pluto and Neptune are in a 2:3 mean motion resonance). This is interpreted as a signature of the dynamic evolution of the planetary system and in particular the inward migration of the planets.

TRAPPIST-1 has been observed by many telescopes including using the High Acuity Wide field K-band Imager (HAWK-I)

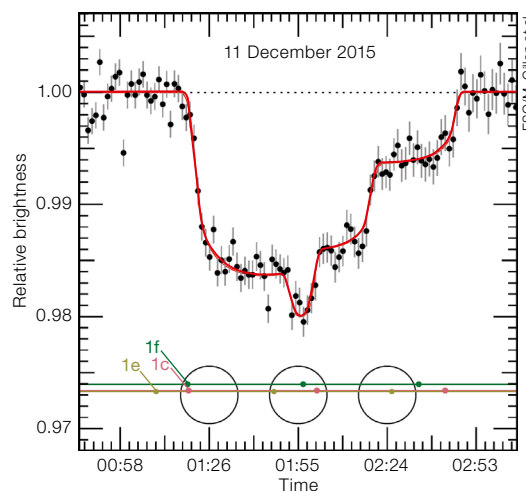

Left: HAWK-I observations of the transit of three planets in front of their host star. As the system is so closely packed, this light curve shows overlapping transits caused by the almost simultaneous passage of three planets in front of the stellar disc. The different absorption depths and durations indicate the sizes and orbital velocities of the individual planets.

Below: Artist's impression of the planets around TRAPPIST-1, all of which are approximately Earth-sized.



on the VLT. Space telescopes provide the long time series data required to obtain orbital information on the most distant planets. By combining all the available information it has been possible to deduce that two of the planets likely have rocky interiors and the other five

require envelopes of volatiles in the form of thick atmospheres, oceans or ice. In most of these cases the water fraction is below 5%.

Other nearby stars with planets that probably have temperate surface tem-

peratures were also found in 2017. The observations bode well for future projects, including a number of space-based missions, which will discover many more exoplanet transits and, quite likely, eventually a world that may look not too different from Earth.

Zooming in on the Galactic Centre and its supermassive black hole

Sgr A*, the supermassive black hole at the centre of our Galaxy, and its surroundings have long been a focus of study for ESO's telescopes. This region is called the Galactic Centre, and is a complex and rich environment that experiences a high rate of star formation, and in which the gravitational field of Sgr A* dominates the motions of the surrounding objects. By studying the movements of the surrounding stars, astronomers can trace their orbits and estimate the mass of and distance to Sgr A*. The stellar orbits have been monitored for decades, driving the development of near-infrared and optical high-angular-resolution instruments, using adaptive optics, at both the Keck Observatory and ESO. In 2017, a 25-year effort to follow the orbits of 47 stars using the NTT, Keck, and the Nasmyth Adaptive Optics System (NAOS) and the near-infrared imager and spectrograph CONICA (together known as NACO) and the Spectrograph for INtegral Field Observations in the Near Infrared (SINFONI) at the VLT, led to a best estimate of the mass and distance of Sgr A*: 4.3 ± 0.2 million solar masses and $27\,100 \pm 500$ light-years, respectively (Gillessen et al., 2017).

These latest estimates of mass and distance are not, however, the end of the story. As impressive as they are, the future of Sgr A* studies is even more exciting. The supermassive black hole creates such a massive gravitational well that the stellar orbits should be affected in accordance with the predictions of General Relativity. To date, no relativistic effects on stellar orbits have been observed because instruments have not had the requisite sensitivity to detect the expected minute deviations from Newtonian physics. But

measuring these effects would offer a verification of General Relativity in a strong gravity regime that has never probed before.

This motivated the construction of the VLTI instrument GRAVITY. By improving the precision of the VLT's adaptive optics, GRAVITY will be able to detect General Relativity effects affecting the closest known star to Sgr A*, S2, as it experiences its closest passage to the supermassive black hole in 2018. GRAVITY was installed and commissioned in 2015-2016 and began observations of Sgr A* and S2 in 2017. Early results showed the expected performance leap provided by optical interferometry, combining the four Unit Telescopes of the VLT (GRAVITY Collaboration, 2017a & b). GRAVITY will also

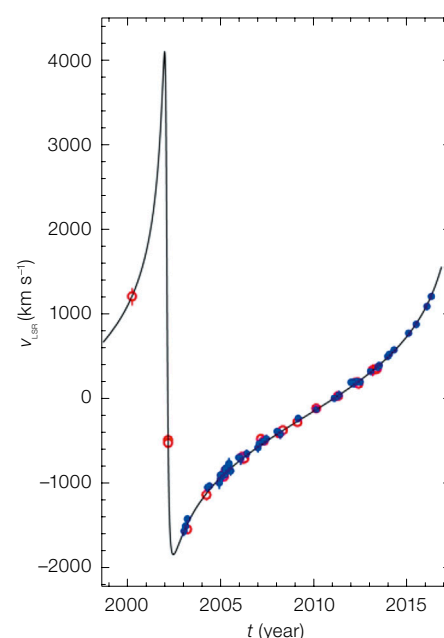
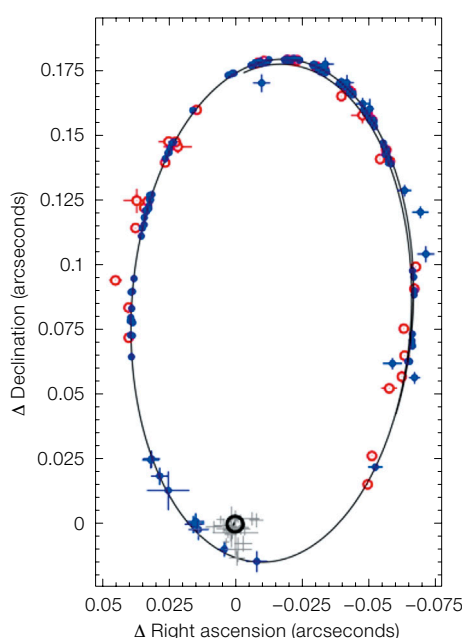

Left: Orbit of the star S2 around the supermassive black hole SgrA* as seen on the plane of the sky. Blue data points are measurements from the NTT and VLT, while the red data points are from Keck. The Sgr A* flare positions are shown as grey crosses. Right: The corresponding radial velocity of S2 as a function of time (Gillessen et al., 2017).

search for additional stars that are fainter and closer to Sgr A*, which would be expected to display even stronger relativistic effects. This search has so far been unfruitful, but the detection limit improves as more data are accumulated every month. Another aspect of Sgr A* that GRAVITY is studying is the nearly daily occurrence of hour-long light “flares” that appear to come from the centre of mass of Sgr A*. The nature of these brightening events is unknown and GRAVITY

is contributing where it excels: angular resolution.

Early observations with GRAVITY confirmed that the flares did indeed originate a few Schwarzschild radii from the central mass (GRAVITY Collaboration, 2017a & b) indicating that the flares are very closely associated with the central black hole. Whatever the nature of the flares, their proximity to the central black hole makes them unique probes of extreme gravity. 2017 has been one of the most exciting years in terms of studies of Sgr A*, but the years to come promise to be even more interesting.

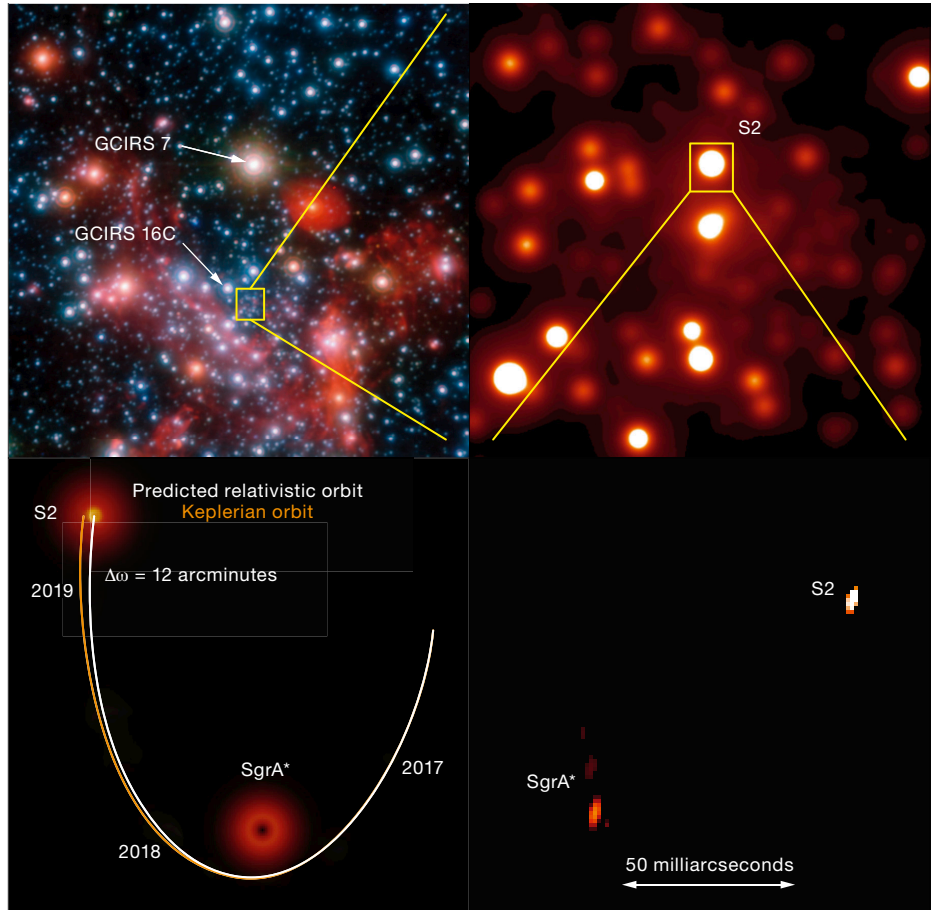

The central 20 arcseconds of the Galactic Centre observed using adaptive optics. Top left: The central 20 arcseconds in the Galactic Centre with the adaptive optics and fringe-tracking reference stars. Top right: The central arcsecond as seen by NACO. Bottom left: The small shift (~12 arcminutes) between the predicted Keplerian and relativistic orbits of S2. Bottom right: First detection of Sgr A* by GRAVITY; the slight elongation is a projection effect and not real (GRAVITY Collaboration, 2017b).

Observing the Sun with ALMA

ALMA is the first ESO observatory designed to observe the Sun directly. At millimetre wavelengths, ALMA is probing the solar chromosphere, the heated layer above its photosphere. By observing the Sun over a range of millimetre wavelengths, ALMA allows us to probe different depths in the solar chromosphere in an attempt to answer the outstanding questions about the heating of the solar chromosphere and the transfer of energy from the photosphere to the higher layers of the solar atmosphere. In 2017, the first regular observations of the Sun started with ALMA and the first high-angular-resolution observations at 3 and 1.25 mm, probing different layers of the chromosphere, were published.

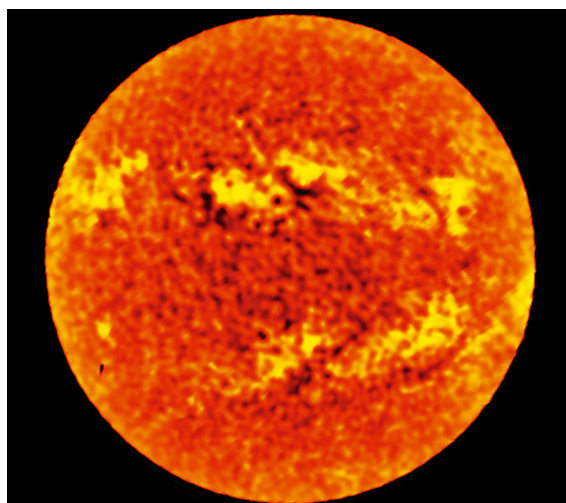

This image of the whole disc of the Sun was taken with ALMA, using a technique called fast-scanning, at a wavelength of 1.25 millimetres. It shows the distribution of temperatures in the chromosphere over the whole disc at low spatial resolution, revealing details about heating in the outer layers of the Sun.

Complex organic molecules

ALMA is the prime ESO observatory studying the chemical pathways that may lead to the development of complex organic molecules (and potentially prebiotic molecules) in the interstellar medium and in the environments where planetary atmospheres are assembled.

Important results in this area obtained in 2017 included the detection of two key molecules in a young solar analogue: methyl isocyanate (CH_3NCO) and freon-40 (CH_3Cl). CH_3NCO is a principal building block of biotic molecules as it is thought to be involved in the formation of molecules like peptides and amino acids. Its detection supports the idea that the pathway to produce these prebiotic molecules is widespread in planet-forming environments. CH_3Cl was thought to be only rarely produced in the interstellar medium. It is found to be abundant in young forming planetary systems and its detection on comet P67/Churyumov-Gerasimenko in our own Solar System suggest that its chemistry can be very effective even outside planetary atmospheres.

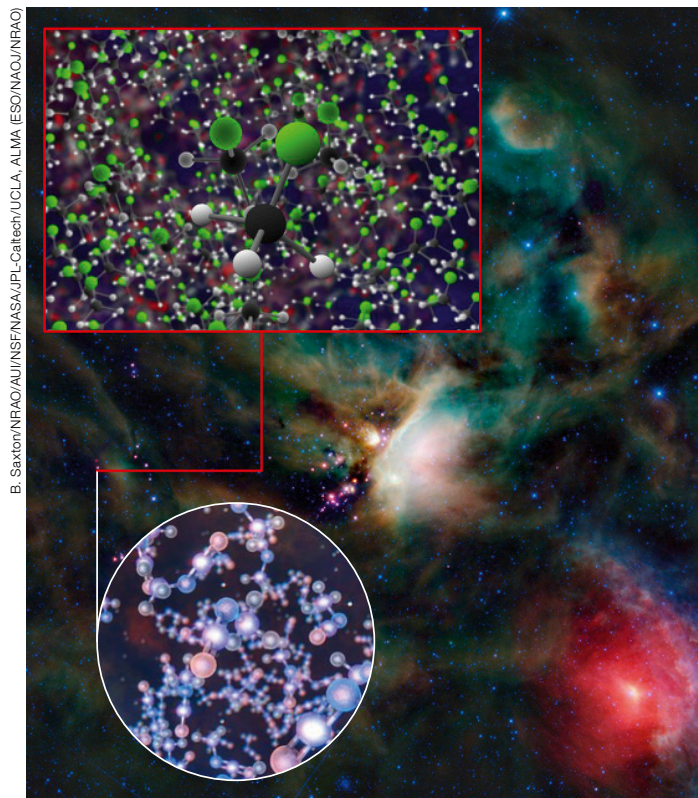

Spitzer Space Telescope infrared image of a young stellar cluster in the rho-Ophiuchi star-forming region. The images show an artist's representation of the complex organic molecules (freon-40 and methyl isocyanate) potentially involved in key life-related chemical reactions detected with ALMA.

Turbulent gas reservoir in early Universe starbursts

ALMA's spectroscopic sensitivity was key to the detection and study of the molecular gas associated with high-redshift starbursts. Observations of carbon hydride (CH^+) in lensed submillimetre galaxies revealed the physical conditions of gas in the environment of these distant starbursts. CH^+ is a highly unstable molecule and is present in high abundance only in regions within molecular clouds where turbulence is dissipated. The detection of CH^+ thus reveals the presence of large reservoirs of cold turbulent gas around high-redshift star-forming galaxies.

The scenario emerging from these observations is one of violent starbursts producing vast galaxy-sized winds that transfer energy from the star-forming events to the gas reservoir around the galaxy. By driving turbulence in the cold gas reservoir, these winds may trigger

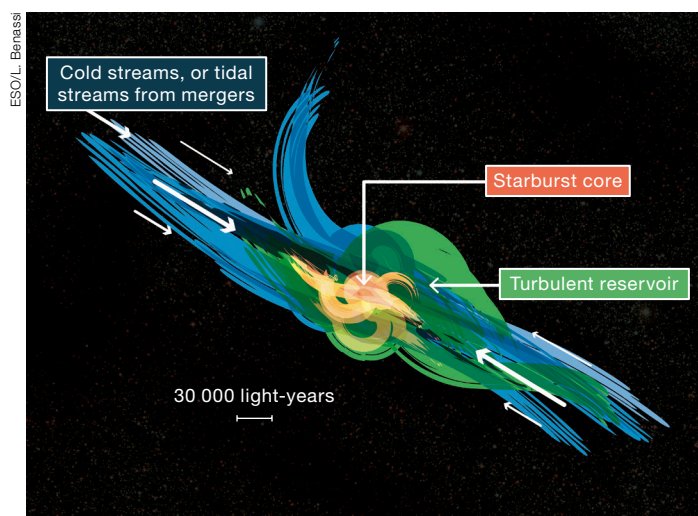

Artist's impression showing how gas falling into distant starburst galaxies ends up in vast turbulent reservoirs of cool gas extending 30 000 light-years from the central regions. ALMA has been used to detect these turbulent reservoirs of cold gas surrounding similar distant starburst galaxies. By detecting CH^+ for the first time in the distant Universe, this research opens up a new window of exploration into a critical epoch of star formation (Falgarone et al., 2017).

an expansion of the starburst activity. These results suggest that feedback is not only responsible for quenching the

star formation activity on galactic scales, but can actually help to extend the star formation activity.

Mass loss from evolved stars

In the final stages of their evolution, stars return a large fraction of their mass to the interstellar medium in the form of reprocessed matter. Heavy elements produced inside the star during its lifetime are ejected from the stellar atmosphere in a series of mass-loss events. Up to 70% of all the dust in the present-day Galactic interstellar medium originates from evolved stars during the evolutionary phase known as the asymptotic giant branch.

Since the beginning of science operations, ALMA has established itself as the prime instrument with which to study mass ejection processes from evolved stars. The sensitivity, angular resolution and image fidelity provided by ALMA are all key elements that allow the detailed reconstruction of the three-dimensional structure of the winds and periodic mass ejections associated with thermal pulses in evolved stars.

Recent observations of the star U Antliae are a perfect demonstration of the revolution that has begun in this field thanks to ALMA. The mass ejection occurred approximately 2700 years ago, around the date of the foundation of Rome. The ALMA high-resolution data reveal a filamentary structure within a beautifully symmetric spherical shell. This structure may be caused by instabilities at the interface between the high velocity mass ejection event and the slower (and less massive) pre-existing wind.

The evolved star U Antliae, as observed by ALMA. Upper: CO integrated intensity map. Lower: colour-coded image revealing the gas moving towards the observer (blue) and away (red) from the star on the plane of the sky.

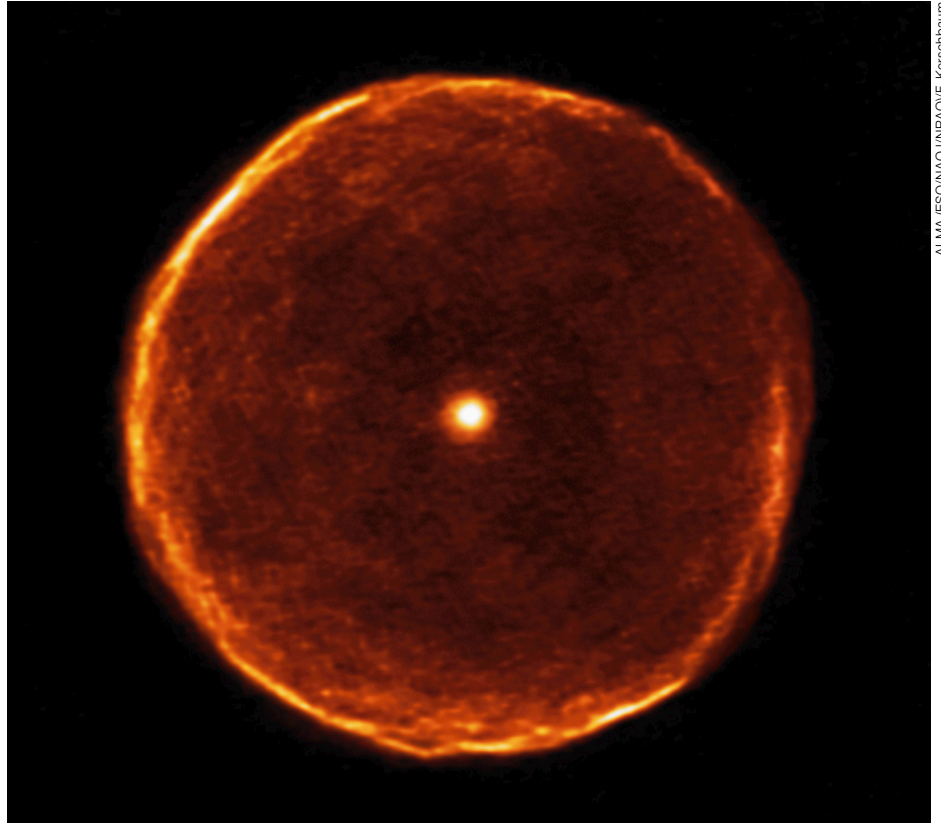

ALMA (ESO/NAO/JNRAO)/F. Kerschbaum

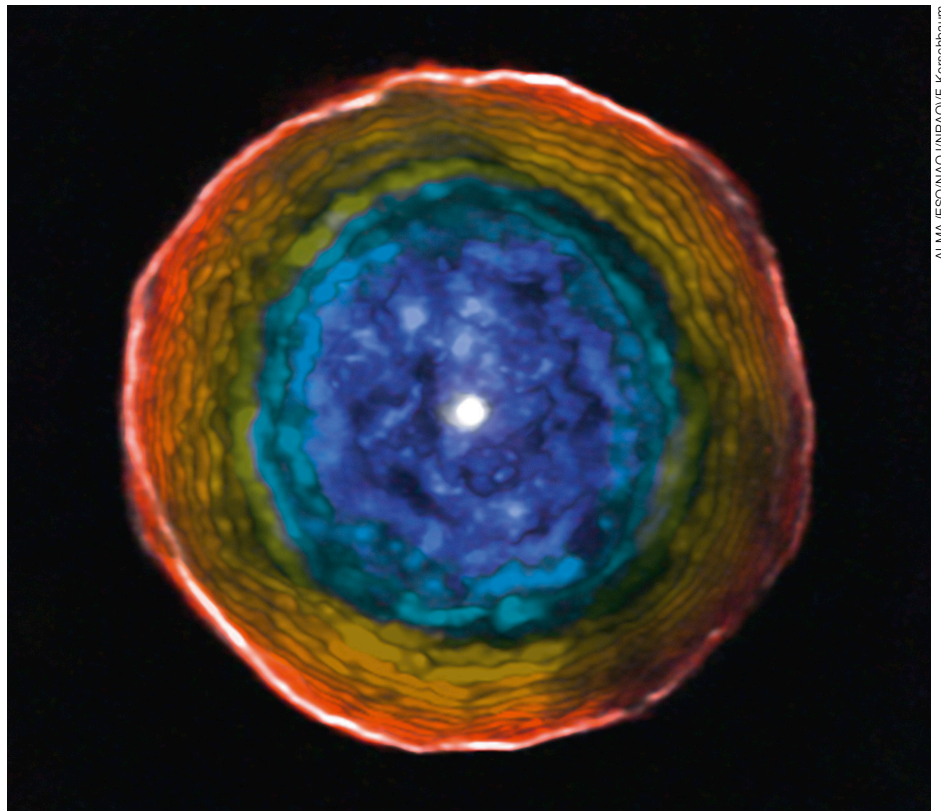

ALMA (ESO/NAO/JNRAO)/F. Kerschbaum

References

The following papers were used as sources for the research highlights.

Bastian, T. S. et al. 2017, *ApJ*, 845, L19
De Wit, J. et al. 2018, *Nature Astronomy*, 2, 214
Falgarone, E. et al. 2017, *Nature*, 548, 430
Fayolle, G. et al. 2017, *Nature Astronomy*, 1, 703
Fitzsimmons, A. et al. 2018, *Nature Astronomy*, 2, 133
Gillissen, S. et al. 2017, *ApJ*, 837, 30
Gillon, M. et al. 2017, *Nature*, 542, 456
GRAVITY Collaboration: Abuter, R. et al. 2017a, *A&A*, 602, A94
GRAVITY Collaboration: Abuter, R. et al. 2017b, *The Messenger*, 170, 10
Grimm, S. et al. 2018, *A&A*, in press, arxiv:1802.01377
Kerschbaum, F. et al. 2017, *A&A*, 605, 116
Ligterink, N. F. W. et al. 2017, *MNRAS*, 469, 2219
Luger, R. et al. 2017, *Nature Astronomy*, 1, 129
Martín-Doménech, R. et al. 2017, *MNRAS*, 469, 2230
Meech, K. et al. 2017, *Nature*, 552, 378
Pian, E. et al. 2017, *Nature*, 551, 67
Smartt, S. et al. 2017, *Nature*, 551, 75
Tanvir, N. et al. 2017, *ApJ*, 848, 27

The La Silla Observatory at sunset.

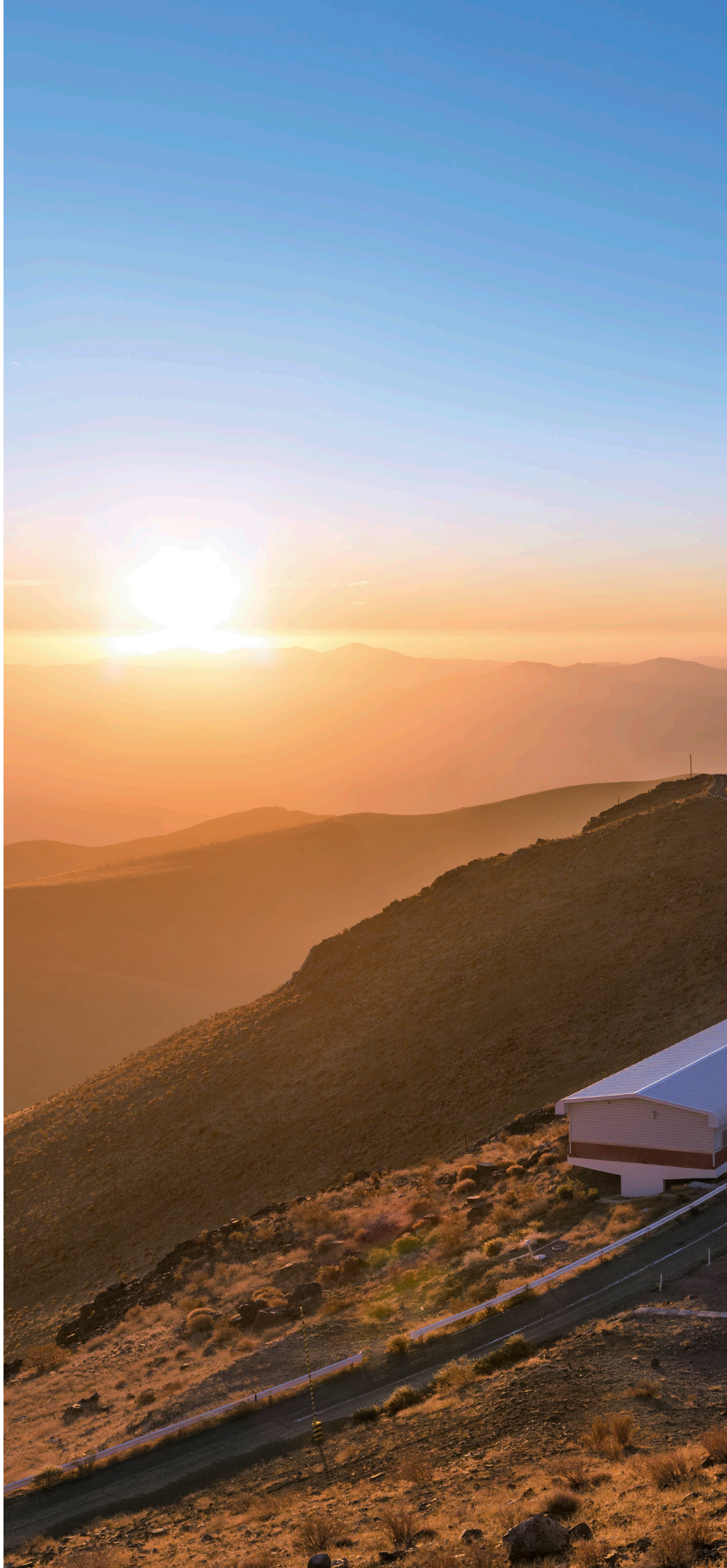



Offices for Science

The main mission of the Offices for Science in Garching and Vitacura is to establish a successful “scientific ecosystem” at ESO by supporting individual research programmes and maintaining a stimulating scientific environment across the organisation through a number of activities, including the ESO studentship, fellowship and visitor programmes. Astronomers across the Organisation make up the ESO Faculty and are deeply engaged in the work of the offices — indeed they run the vast majority of the selection committees for the Offices for Science programmes.

The Chair of the ESO Faculty also chairs the Scientific Personnel Committee, arguably one of the most important internal committees as it evaluates the scientific credentials of astronomers during hiring, contract renewal, and promotion and when evaluating indefinite contracts. Over the last five years, the Director for Science, the Offices for Science and the Faculty Chair have been working together to further empower the ESO Faculty and this process will continue in 2018, with the offices being reorganised to include the participation of the Faculty Chair. These changes are in line with the 2013-2014 Visiting Committee recommendations to promote the Faculty’s role in ESO’s programmes and day-to-day operations.

Faculty activities in 2017

In 2017, members of the Faculty participated in several working groups to assess the status of ESO’s fellowship and studentship programmes, to reorganise the flow of talks and colloquia on both sites and to define a sabbatical programme (called “Research Periods”) for the Faculty. The fellowship and studentship working groups found that these programmes are successful and provided recommendations to further improve the selection process. For studentships, the Faculty recommended establishing a second yearly call to better align with external constraints — a suggestion that was quickly implemented. In addition, the selection committees for the studentship, fellowship and visitor programmes consist solely of Faculty members with minimal involvement from the Heads of the Offices for Science. The frequency of talks was also

readjusted based on recommendations by the Faculty. Finally, a cost-neutral pilot Research Period programme was established, allowing one Faculty astronomer on each site to take one year out to focus entirely on their research and reinforce their collaborations and connections with the community. The first round of applications will be assessed in 2018.

Strengthening the fellowship programme

Over the last few years, ESO implemented a way for fellows to formally supervise students and to lead a variety of projects; for example, fellows can bid for grants from the Science Support Discretionary Fund (previously called the Director General’s Discretionary Fund) and fellows can also propose and lead ESO workshops. These changes keep the fellowship programme competitive compared to postdoctoral opportunities available at ESO Member State research institutes and universities and help fellows to gain key skills in preparation for a successful career as an astronomer.

Science highlights

As in previous years, we take the opportunity here to showcase the achievements of a few ESO researchers, to further illustrate the abundance of talent among both junior and senior staff members.

Dinko Milaković is a second-year International Max Planck Research School on Astrophysics (IMPRS) student who joined ESO in September 2016. Dinko previously studied at the University of Zagreb (Croatia) and was an intern at the University of New South Wales (UNSW) in Australia. His PhD, conducted under the supervision of Luca Pasquini and John Webb (UNSW), concerns cosmology and fundamental physics, aiming to refine high-redshift measurements of the value of the fine structure constant and to test whether it varies with time and/or spatial direction. This requires high-resolution quasar spectra with exquisite wavelength calibration.

Dinko began his PhD with a trip to La Silla to learn about the use of Laser Frequency Combs (LFC), which will refine the accu-

racy of the wavelength calibration of the High Accuracy Radial velocity Planet Searcher (HARPS) (and ESPRESSO) instrument to a velocity of 1 m s^{-1} . In 2017, Dinko joined the ELT students & fellows working group, where he simulates observations of quasar spectra from the proposed ELT high-resolution spectrograph HIRES. Dinko is a student representative and one of the co-organisers of both the Journal Club and Beer Friday in Garching. He has also acted as facilitator twice during ESO’s peer review, during which observing proposals are assessed, and fielded questions during an “Ask an Astronomer” event at the ESO Open House. Dinko also chaired the local organising committee for the third IMPRS Student Symposium, and more recently he played a key role in developing and implementing a new concept for “Science Day” at Garching in January 2018, the purpose of which is to enable ESO astronomers to interact and get to know more about each other’s research.

Andra Stroe started as an ESO Fellow in Garching in October 2015 after a PhD at Leiden Observatory (the Netherlands). Her research brings together multi-wavelength observations and modelling to study the evolution of galaxies, gas and active galactic nuclei (AGN) with cosmic time and environment, focussing on the growth of galaxy clusters. Andra leads a large international observational effort aimed at understanding the triggering of star formation and AGN activity during massive cluster mergers. The first paper from this project was published in 2017. It was based on 35 nights of observations and presented the largest sample obtained so far (> 3000) of uniformly selected emission-line cluster galaxies. The data showed conclusively for the first time that merging clusters have twice as many star-forming galaxies on average compared to their relaxed cluster counterparts. Andra has shared her results with the community, giving 13 talks in 2017, including eight invited talks and colloquia.

Andra chose to do her fellow duties in Paranal and is involved in the operations of UT1, where she serves as a night-time astronomer for the FORS2 and NACO instruments and the K-band Multi Object Spectrograph (KMOS). Using her experience as a support scientist at Paranal

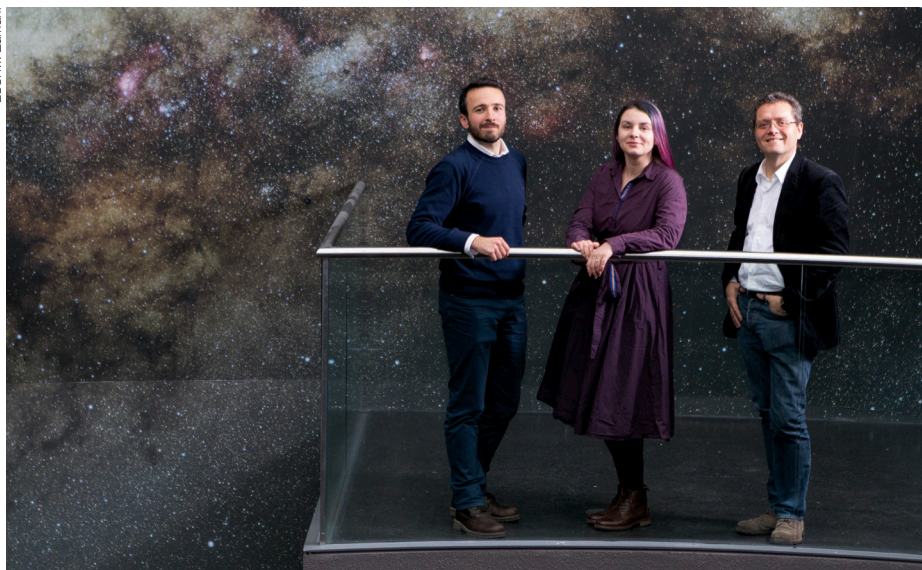

Dinko Milaković, Andra Stroe and Leonardo Testi inside the ESO Supernova Planetarium & Visitor Centre.

and drawing on her collaborations, Andra has six ongoing observing programmes. These span almost the entire electromagnetic spectrum (including radio, sub-millimetre, infrared, optical and the ultraviolet), and use the VLT (with KMOS, the Fibre Array Multi Element Spectrograph [FLAMES] and X-shooter) as well as APEX. In July 2017, Andra led the organisation of the ESO workshop “Early stages of Galaxy Cluster Formation” with staff member Tony Mroczkowski, which brought 110 experts together at ESO Headquarters. Andra also served as a member of the ESO Garching fellowship selection committee, founded the Galaxy Cluster discussion group and organises Wine and Cheese seminars.

Leonardo Testi joined ESO in May 2007 as European ALMA Programme Scientist and was promoted into the role of Head of the ESO ALMA Support Centre (EASC) in 2017. Leonardo started his career as an infrared and radio astronomer. Even though he shifted his focus to (sub-) millimetre astronomy, first as a postdoc at Caltech and then through his work with ALMA, he continues to use a variety of state-of-the-art instruments and techniques for his research including all of the ESO observatories. His scientific interests

Yara Jaffé, Thomas Rivinius and James Leftley at Vitacura.

include the interstellar medium, young stellar clusters, star and planet formation and brown dwarfs.

Leonardo is on leave from the Italian National Institute for Astrophysics (INAF), where he contributed to the development of submillimetre astronomy, first as a member of the INAF Science Council and then as the coordinator of the iALMA initiative, which provided funding for a broad range of ALMA-related scientific and technical research in Italy. Leonardo has a passion for and commitment to outreach and working with students and fellows, tutoring and mentoring the next generation of astronomers. His substan-



tial contributions to the study of the properties of solids and volatiles in planet-forming discs and of the Galactic interstellar medium are made possible by these highly talented young people.

Leonardo’s research on the statistical properties of discs has received support from the Deutsche Forschungsgemeinschaft (DFG) via the Excellence Cluster Origin and Structure of the Universe, through which he co-organised a Munich Institute for Astro- and Particle Physics 2017 workshop. He also recently received support from a DFG network research grant in collaboration with groups at universities in Munich, Heidelberg and Tautenburg, and at the Max Planck institutes for extra-terrestrial physics and astronomy.

Thomas Rivinius joined ESO as a fellow in Garching in 1999, opting to carry out his functional duties at the Paranal observatory at UT2, and he re-joined ESO in 2005 as a faculty astronomer in Chile. With a background in spectroscopy, Thomas expressly sought a position at the VLTI in order to expand his observational and technical skills and he became the instrument scientist responsible for the interferometric instruments the MID-infrared Interferometric instrument (MIDI) and the Precision Integrated-Optics Near-infrared Imaging Experiment (PIONIER). Thomas is now involved in the commissioning of MATISSE, and will be its instrument scientist after it is handed over to ESO.

Thomas's science concentrates on stars that are more massive than the Sun. His interests include binarity, massive stellar winds over circumstellar discs, magnetic fields and stellar pulsations. Be stars, B-type stars with circumstellar gas discs, are his main focus at present. This allows him to fully exploit his skills, as many Be stars are nearby and bright, making them prime targets for both spectroscopy and optical interferometry. Thomas brings his observational expertise to collaborations with theoretical astrophysicists in Brazil, the USA and Canada, as well as with colleagues from ESO. He is actively involved in the supervision and support of students including those working directly with him in Chile and those working with his collaborators.

Yara Jaffé joined ESO Chile as a fellow in late 2015. As the Multi Unit Spectroscopic Explorer (MUSE) Instrument Fellow, Yara has played an important role in the deployment of the Adaptive Optics Facility (AOF) on Yepun (UT4). She has also contributed to the Science Operations team by leading instrument-related projects and supervising a short-term student at Paranal. In Santiago, Yara has been very committed to science outreach. She co-organised an "Astronomy for everyone" event at Vitacura and participated in many outreach and educational events in Chile, including the *Festival Internacional de Innovación Social* (FIIS 2017). Yara also served on the fellowships and studentships selection committee in Chile.

Yara's main scientific goal is to understand the physical mechanisms transforming galaxies in different cosmic environments. Her most recent work focused on the role of ram-pressure stripping by the intracluster medium in the quenching of galaxies. In particular, she is a core team member of the ESO Large Programme GAs Stripping Phenomena in galaxies (GASP; Principal Investigator [PI] Poggianti), which aims to understand gas-stripping phenomena in galaxies using MUSE. On completion the programme will have collected 3D data for over 100 galaxies undergoing gas stripping (called "jellyfish galaxies" because of their spectacular tails). Yara has worked on linking the "jellyfish" morphology and kinematics revealed by MUSE GASP observations to ram-

pressure stripping in clusters. She also played a key role in the discovery of a previously unknown connection between ram-pressure stripping and AGN activity in cluster galaxies. Yara also co-supervises Callum Bellhouse, a PhD student who spent two years at ESO working on GASP data, and who recently returned to the University of Birmingham to finish his thesis.

James Leftley joined ESO in late 2016, at the beginning of his PhD at the University of Southampton, to work with Konrad Tristram and Daniel Asmus. His main goal during his time at ESO is to use infrared interferometry to directly observe the dust distribution in the central tens of parsecs of nearby AGN. During 2017 he used MIDI to study dust on the scale of the obscuring dust torus in a local Seyfert AGN. Recently James was awarded time with GRAVITY to further study the same AGN in the near-infrared. In early 2017 he was a visiting astronomer at the VLTI on the Astronomical Multi-BEam combineR (AMBER) from which he gained experience of observing faint objects with a near-infrared interferometer. He plans to use the insight gained to make the most of GRAVITY in AGN science and measure distances to a larger sample of local, deriving the Hubble constant independently of the cosmic distance ladder.

During his time at ESO James has taken advantage of opportunities to gain experience in the use of virtual reality and 3D modelling in astronomy. He provided input to a new virtual reality system for ESO Vitacura, which will allow the visualisation of large datasets that are being produced by newer instruments, to the benefit of both researchers and members of the general public. James also joined the Santiago AGN group, which organises monthly meetings bringing together researchers at ESO and universities in Santiago working on related topics.

This image shows one of the four 1.8-metre Auxiliary Telescopes of the VLTI at Cerro Paranal.





Allocation of Telescope Time

The table shows the requested and scheduled observational resources for Periods 100 and 101 (October 2017–March 2018 and April–September 2018, respectively) for the La Silla Paranal Observatory and APEX. The length of each run is specified in nights, the usual allocation unit for the La Silla Paranal Observatory and APEX.

The La Silla Paranal Observatory and APEX statistics only include proposals submitted for the two periods (P100 and P101). Large Programme runs that were approved in previous periods, Guaranteed Time Observing (GTO) runs, and Public Survey runs are not included. The pressure is computed as the ratio between the requested and the allocated time. The last two columns present the total telescope time allocations and the fractions of time per instrument. Note that the Visible Multi-Object Spectrograph (VIMOS) was almost fully dedicated to two Public Spectroscopic Surveys in Periods 100 and 101. As only a very limited amount of time was allotted to open time programmes, the pressure on VIMOS was unusually high over this time.

The ALMA Proposal Review Committee for the allocation of time in Early Science Cycle 5 (covering October 2017–September 2018) met in Antwerp, Belgium between 18 and 23 June 2017. The table shows the requested and scheduled resources for the ALMA Observatory in Cycle 5 listed by ALMA frequency band, for ESO and the world (including North America, East Asia, ESO and the host country Chile). The scheduling unit for ALMA is an hour of array time.

Note that the total number of ALMA proposals is less than the sum of the numbers above, as proposals can request more than one band.

This is a composite made by combining archival images of NGC 6822 from the Wide Field Imager (WFI) at the La Silla Observatory and new ALMA data. The ALMA observations reveal the detailed structure of star-forming gas clouds.



ESO, ALMA (ESO/NACU/NPAO)/A. Schrüba, V.L.A (NRAO)/Y. Bagetakos/Little THINGS

Telescope	Instrument	Requested runs	Scheduled runs	Requested time	%	Scheduled time	%	Pressure	Total allocation	%
UT1	NACO	75	35	70	11.8%	19	15.8%	3.7	55	24.8%
	FORS2	345	101	376	63.9%	88	73.7%	4.3	109	49.3%
	KMOS	74	10	143	24.2%	13	10.6%	11.3	57	26.0%
Total		494	146	588		119		4.9	221	
UT2	FLAMES	88	17	145	15.5%	29	14.7%	5.0	49	21.2%
	UVES	206	45	298	32.0%	46	23.0%	6.5	53	22.8%
	X-SHOOTER	376	122	489	52.5%	124	62.3%	4.0	130	56.0%
Total		670	184	931		199		4.7	233	
UT3	SPHERE	219	104	220	60.3%	55	59.8%	4.0	118	47.3%
	VIMOS	21	13	33	9.0%	1	1.4%	25.1	85	34.2%
	VISIR	94	45	112	30.7%	35	38.8%	3.2	46	18.5%
Total		334	162	364		91		4.0	248	
UT4	SINFONI	146	22	177	26.5%	29	36.8%	6.0	48	32.8%
	MUSE	369	41	419	62.6%	42	52.3%	10.0	87	59.5%
	HAWK-I	86	17	72	10.8%	9	10.9%	8.3	11	7.8%
Total		601	80	669		80		8.4	147	
VLTI	AMBER	31	6	22	12.8%	6	8.6%	3.5	6	5.5%
	PIONIER	75	32	48	27.9%	30	40.5%	1.6	33	28.3%
	GRAVITY	165	77	103	59.3%	37	50.9%	2.8	77	66.2%
Total		271	115	173		74		2.4	116	
3.6-metre	HARPS	135	109	522	100.0%	265	100.0%	2.0	330	100.0%
Total		135	109	522		265		2.0	330	
NTT	EFOSC2	58	29	204	28.2%	94	46.9%	2.2	145	45.0%
	SOFI	18	18	61	8.4%	55	27.3%	1.1	106	32.9%
	Visitor Instrument	38	18	458	63.3%	52	25.8%	8.9	71	22.1%
Total		114	65	723		200		3.6	321	
APEX	ARTEMIS	2	1	4	3.2%	1	2.5%	3.0	3	5.8%
	LABOCA	5	2	20	16.5%	4	8.2%	4.8	4	7.9%
	PI230	7	4	14	11.7%	8	14.6%	1.9	8	14.1%
	SEPIA	16	7	40	32.8%	14	27.2%	2.9	14	26.3%
	SHFI	14	8	44	35.8%	25	47.6%	1.8	25	46.0%
Total		44	22	122		52		2.4	53	
ALMA	Band	Req. proposals/band All ESO	Sched. proposals/band (A+B) All ESO	Requested hours All ESO		Scheduled hours (A+B) All ESO		Pressure (by hours) All ESO		
	3	506 213	127 41	4692 2073		1229 377		3.82 5.50		
	4	178 84	44 12	1276 619		275 73		4.64 8.46		
	5	113 62	33 14	674 395		142 59		4.75 6.70		
	6	764 303	212 70	6933 2673		1635 537		4.24 4.98		
	7	567 233	132 43	4230 1839		828 339		5.11 5.43		
	8	98 44	27 7	539 242		149 26		3.61 9.42		
	9	93 37	21 6	380 135		74 22		5.15 6.14		
	10	23 6	8 1	96 31		20 2		4.85 15.00		
	Total		1661 701	433 150	18820 8007		4351 1434		4.32 5.58	



A composite of over 50 images taken during the partial lunar eclipse observed at the ESO Headquarters on 7 August 2017.

Publication Digest

The Telescope Bibliography (telbib), a database developed and curated by the ESO Library, is used to evaluate the Organisation's productivity and impact through the number of published papers based on ESO data and through their citations. In 2017, for the first time in ESO's history, the number of refereed articles published by ESO users exceeded 1000 in a single year.

This peak surpasses the previous high of 870 papers in 2012 and is mirrored by excellent statistics from each of the individual observing sites. The number of VLT/VLTI and La Silla papers underwent a significant upswing in 2017. The largest increase occurred for ESO's survey telescopes, VISTA and especially the VST, which generated almost 40% more papers than in the previous year. The number of papers using APEX during ESO time remained stable, while ALMA data obtained during ESO observing time led to 14% more papers than in 2016.

In 2017, approximately 11 000 refereed papers were screened through text-mining and manual verification; this is about 300 papers more than in the previous two years. The ESO publication statistics per site and for the entire Observatory are shown in the bar chart. Before inclusion in the telbib database each paper is carefully examined by the curators to make sure that ESO's selection criteria are met. Details of telbib, tables with links to the papers in the bar chart, and the methodology used to screen papers can be found via the telbib webpage at <http://telbib.eso.org>.

In 2017, the public interface of telbib was enhanced to provide more information about which data were used in a particular paper, and to enable access to reduced as well as raw data for papers that use archival data products. A new checkbox on the telbib interface selects papers that (exclusively or partly) use data obtained from the ESO Science Archive. The display of data links in the detailed record view has been revised so that programmes are grouped by instrument. Instrument names are also connected to the respective instrument pages. In addition, ORCIDs (Open Researcher and Contributor IDs) have been integrated into author records and are displayed in telbib

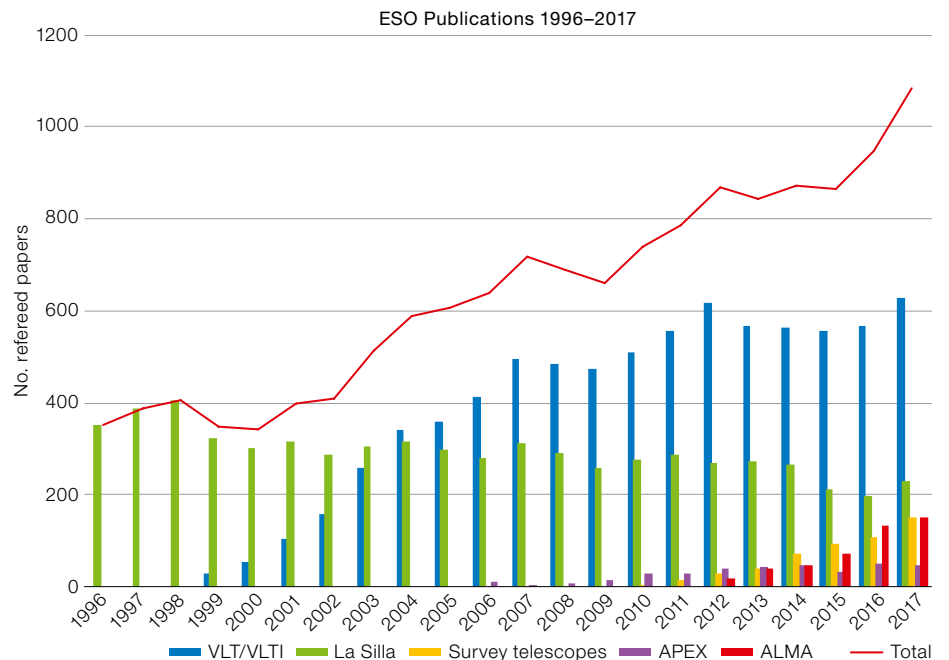

Refereed papers using ESO data, 1996–2017. Some papers use data from more than one facility. VLT/VLTI: papers using data generated by VLT and VLTI instruments, including visitor instruments for which observing time is recommended by the ESO Observing Programmes Committee (OPC), for example, ULTRACAM and PIONIER. La Silla: papers using data from La Silla facilities, including visitor instruments (for example, ULTRACAM). Papers based on data from non-ESO telescopes or observations

obtained during reserved periods (for example, national allocations of time) are not included. Survey telescopes: papers using data from ESO's survey telescopes VISTA and VST. APEX: papers using APEX data, including visitor instruments for which observing time is recommended by the ESO OPC (for example, Z-Spec). ALMA: papers using data generated by ALMA. For APEX and ALMA, only papers based (entirely or partly) during ESO time are included.

DETAILED INFORMATION	
Author(s)	Laporte, Nicolas ; Nakajima, Kimihiko ; Ellis, Richard S. ; Zitrin, Adi ; Stark, Daniel P.; Mainali, Ramesh ; Roberts-Borsani, G. W.
Title	A Spectroscopic Search for AGN Activity in the Reionization Era
Keywords	stars: formation, early universe, galaxies: distances and redshifts, galaxies: evolution, galaxies: formation, infrared: galaxies
Abstract	show abstract
Publication details	ApJ, 2017, vol. 851, p. 40-
BibCode	2017ApJ...851...40L
Fulltext (via ADS)	ADS
DOI	10.3847/1538-4357/aa96a8
Citations (from ADS)	7 1
Instruments and Observing Programmes used:	VIRCAM (VISTA / Paranal) 179.A-2005 (access to raw data and data products), UltraVISTA survey XSHOOTER (VLT / Paranal) 097.A-0043 (access to raw data)
Other tags	Archive + PI

Revised layout and new features of telbib records, including ORCID icons that link to the author's profile page, direct links to raw data and data products in the ESO Science Archive, and icons that provide access to instrument information.

records, providing links to the author's ORCID profile page.

Publications from different sites

The VLT and VLTI contributed data to 630 refereed papers in 2017, surpassing the previous high of 616 papers in 2012. The second-generation VLT instrument X-shooter had been unavailable to the community for some time during Periods 97 and 98 for technical upgrades, but after returning to normal operations it quickly resumed its high level of productivity, with 103 papers in 2017 — an increase of over 50% compared to 2016. The newer second-generation instrument, MUSE, showed an even steeper increase, producing 77 papers in 2017, which is more than in the three preceding years and an increase of more than 60%. Using data from VIMOS on UT3, the public spectroscopic survey called VANDELS — a deep VIMOS survey of the CANDELS fields (UKIDSS Ultra Deep Survey field and Chandra Deep Field South) published its first science paper. On the VLTI, the first seven papers using the second-generation instrument GRAVITY were published.

ESO's survey telescopes, VISTA and the VST, provided data for a total of 152 papers in 2017. The productivity of the VST increased remarkably, resulting in 55 papers, three times more than were published in the previous year (18 in 2016). A slight increase in the use of archival data was noted for these telescopes. The vast majority of VISTA and VST data papers published between 2010 and 2017 (456 out of 510, i.e. 89%) deployed data obtained through the ongoing public surveys. Papers using data from two of the second-generation VISTA public surveys (Vista Near-infrared Observations Unveiling Gravitational wave Events [VINROUGE] and the extended VISTA Variables in the Via Lactea survey [VVVX]) appeared in 2017. The publication statistics per survey are in the upper bar chart.

La Silla facilities are doing remarkably well. An increasing number of telescopes, such as the MPG/ESO 2.2-metre telescope, the Swiss 1.2-metre Leonhard Euler Telescope, and the Danish 1.54-metre telescope, are hosted but not run by ESO, and their papers are not included in the ESO bibliography. Nevertheless the site provided data for nearly 230 refereed papers in 2017. HARPS continues to be outstanding, producing 97 papers

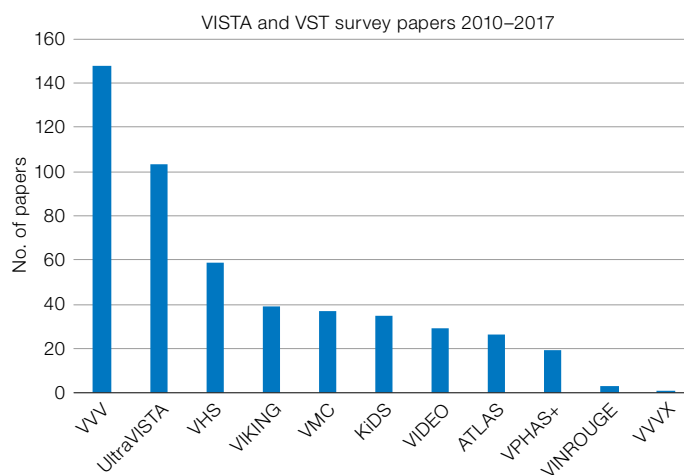

Refereed papers using VISTA or VST Public Survey data between 2010–2017. Papers can use data from more than one survey.

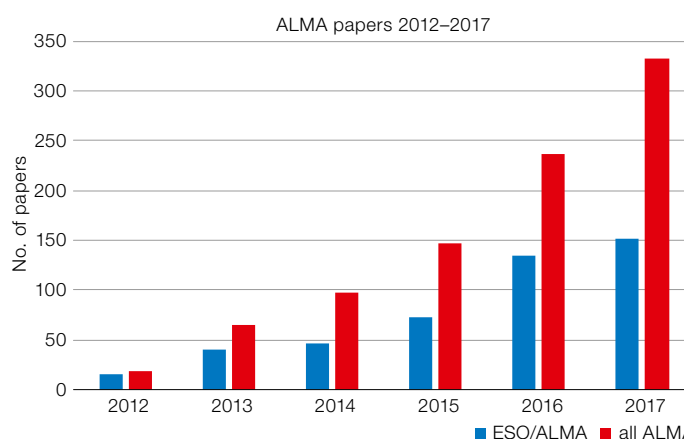

Refereed publications per year based on ESO ALMA time compared to all of ALMA.

in 2017, with the ESO Faint Object Spectrograph and Camera 2 (EFOSC2) and the Fibre-fed Extended Range Optical Spectrograph (FEROS) producing 55 and 40 papers, respectively.

APEX has generated more than 600 data papers since 2006, using observing time from all APEX partners; the Max Planck Institute for Radio Astronomy (MPIfR) has 50% observing time, the Onsala Space Observatory (OSO) has 23% and ESO has 27%. Almost 60% of APEX papers used at least some data obtained during ESO time.

ALMA is a partnership between ESO, East Asia, and North America, in cooperation with the Republic of Chile. Using data from all partners, the ALMA users community published more than 330 papers in 2017, bringing the total number of papers to almost 900 (since 2012). More than half of these papers involved

data taken during the European ALMA time. The number of ALMA data papers per year are shown in the lower bar chart.

The ALMA bibliography is maintained jointly by the librarians at ESO and the National Radio Astronomy Observatory (NRAO) in the USA as well as by the National Astronomical Observatory of Japan (NAOJ). Publications based on data from all ALMA partners are recorded in telbib, but only those based on European observing time are counted in the ESO statistics, unless otherwise noted.

ESO Science Archive Facility

The ESO Science Archive Facility contains data from ESO telescopes and makes them available to the astronomy community. Pls of successful observing proposals have exclusive access to their scientific data for the duration of a

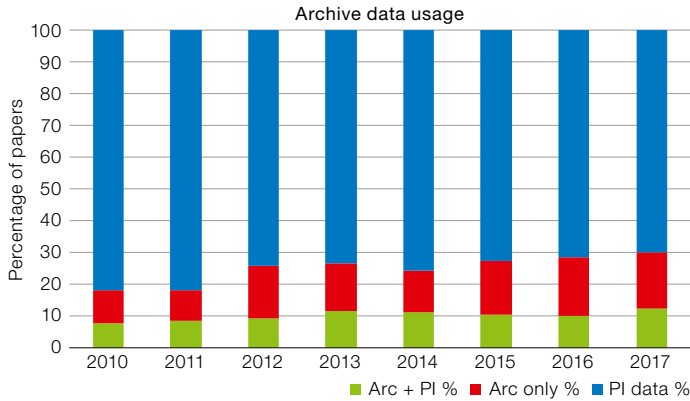

Percentage of papers using data obtained by the team of authors (PI data), obtained entirely from the ESO Science Archive (Arc only), or partly obtained by the team and from the Archive (Arc + PI) for the publication years 2010–2017.

proprietary period, normally one year, after which the data become available to the community at large. In addition to raw data, the archive also provides various types of data products. The fraction of ESO data papers that deploy archival data, either exclusively or in conjunction with data obtained by the authors, has been around 25% since 2012. In 2017, an

increased fraction of almost 30% of the data papers used archival observations, emphasising the importance of the ESO Science Archive Facility for the Organisation's research data infrastructure. The distribution of papers using PI data, archival data, or a combination of both (Archive + PI data) for the years 2010 to 2017 are shown in the bar chart.

The statistics presented here are derived from the ESO Telescope Bibliography (telbib), a database of refereed papers published by the ESO users community that links publications with the data in the ESO Science Archive. telbib is developed and maintained by the ESO Library. It is compiled by scanning articles published in the major astronomical journals for ESO-related keywords (for example, telescope and instrument names). Journals routinely screened for ESO-related keywords are: *A&A*, *A&ARv*, *AJ*, *ApJ*, *ApJS*, *AN*, *ARA&A*, *EM&P*, *ExA*, *Icar*, *MNRAS*, *Nature*, *NewA*, *NewAR*, *PASJ*, *PASP*, *P&SS*, and *Science*. All papers included in the database have been inspected visually by the curators to ensure that they directly use ESO observational data. Further information about telbib and various statistics and reports can be found on the web (http://www.eso.org/sci/libraries/telbib_info.html).

Access to records of all 2017 data papers written by the ESO users community is available at <http://telbib.eso.org/ESODataPapers2017.php>. A separate listing of refereed publications by ESO scientists with or without use of ESO data can be found at http://www.eso.org/sci/libraries/telbib_info/AR/ESOSTaffPapers2017.pdf.



The planetary nebula NGC 7009 (the Saturn Nebula) captured by MUSE on the VLT.

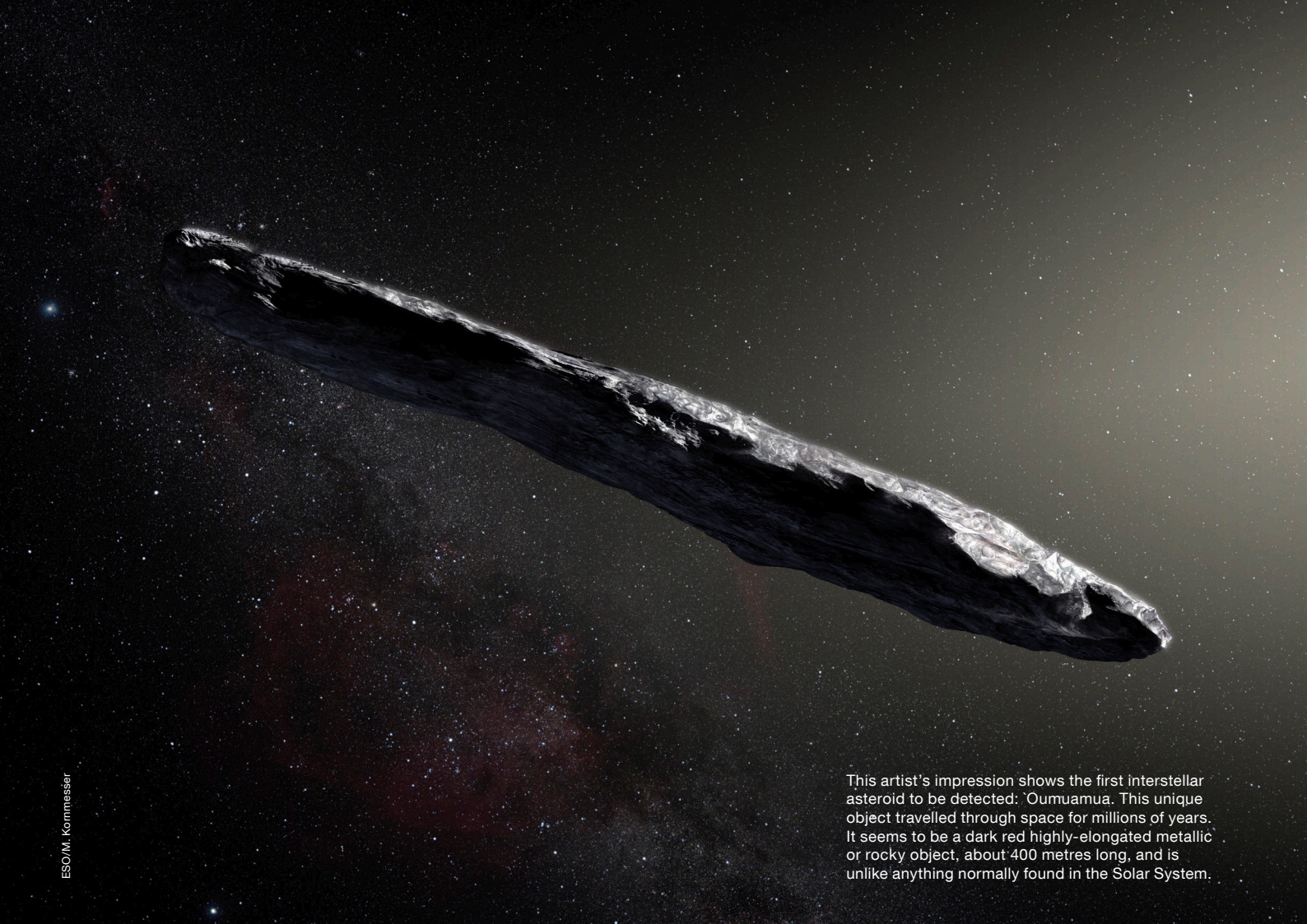

ESO/M. Kornmesser

This artist's impression shows the first interstellar asteroid to be detected: Oumuamua. This unique object travelled through space for millions of years. It seems to be a dark red highly-elongated metallic or rocky object, about 400 metres long, and is unlike anything normally found in the Solar System.



ESO/M. Kornmesser

Artist's impression of the ultracool dwarf star TRAPPIST-1 as seen from the surface of one of its planets.

Education and Outreach

ESO celebrated some remarkable and widely publicised scientific achievements during the year, reaching hundreds of millions of people around the world, and using striking astronomical images, artists' impressions and creative videos to maximise the impact of these results.

The most popular story of the year came in the form of a mysteriously long, thin, spinning interstellar asteroid — the surprise visitor to our Solar System named 'Oumuamua. Coverage of this strange relic from outer space lasted for weeks, as the initial excitement turned to intrigue owing to the odd cigar-like shape of the asteroid and its strange motion. This sparked questions about its origins and even speculation about its being an alien spaceship, and it will likely continue to intrigue scientists as well as the public. ESO — with its remarkable fleet of telescopes (including the upcoming ELT) — is well placed to characterise similar visitors in the future.

In February, astronomers discovered seven Earth-sized planets just 40 light-years away, orbiting the ultra-cool dwarf star TRAPPIST-1. This was the second most popular press release of the year and the initial discovery has led to a number of new findings. Another popular press release reported the discovery of the closest temperate world orbiting a quiet star — Ross 128b. This raised many questions on social media and sparked heated debates about the future of humankind and the possibility of reaching other planetary systems.



ESO/P. Horálek

The ESO Supernova Planetarium & Visitor Centre.

In October, ESO held a successful press conference to mark the emergence of a new type of multi-messenger astronomy, announcing the ground-breaking detection of both gravitational waves and light from a merging neutron star pair, called a kilonova. At least one million viewers watched the online live stream, and ESO's creative artists designed memorable and exciting images and videos illustrating these momentous results.

ESO's biggest outreach project to date, the ESO Supernova, is getting closer to becoming a fully-realised planetarium and visitor centre. The biggest part of the planetarium's technical installation was concluded in 2017 and effort was invested in producing inspiring planetarium shows, exhibition content and educational workshops, as well as in preparing the opening campaign.

2017 also saw important progress with the construction of the world's "Biggest Eye on the Sky", ESO's ELT. In June, the First Stone ceremony was held and the Director General was joined by the President of the Republic of Chile to mark this historic occasion.

The "Our Place in Space" Hubble exhibition, produced for the European Space

ESO press conference announcing the first discovery of a neutron star merger and its electromagnetic counterpart, a kilonova.



ESO/M. Zamani

Agency (ESA), was shown in Venice, and will come to the ESO Supernova in May 2018. The exhibition, which attracted almost 30 000 visitors over two months, showcased the beautiful images that Hubble has captured over the last 28 years.

Finally, the ESOblog was launched (<https://www.eso.org/public/blog/>), to provide a glimpse behind the scenes at ESO and insights into the many facets of ESO's organisation and its staff.

Press activities

In 2017, 41 press releases were issued, including 17 science releases, several of which had very high impact. The number of requests for consideration as potential press releases continues to increase. In addition to the large number of very high-profile ESO-related science results there were several news items

announcing the arrival of new telescopes and instruments at all of ESO's sites and key ELT milestones. ESO Pictures of the Week continue to be an effective way to report on news items that do not require a full press release; these are also routinely picked up by the wider media.

Over 75 formal interview requests were received from media worldwide, resulting in extensive coverage, especially in the case of the gravitational wave event in October.

Seventeen weekly posts on the ESOblog were released since it started in September 2017. A smaller blog series of seven posts featuring infographics was also featured, which explored ALMA's involvement in the efforts of the Event Horizon Telescope (EHT) and the Global millimetre-VLBI Array (GMVA) to image the shadow of the event horizon of the supermassive black hole at the centre of the Milky Way. Finally Outreach also continued to cover

the press activities for ESA/Hubble and the International Astronomical Union, including press releases, announcements and Pictures of the Week.

Publications

ESO produces a wide range of print products (for example, periodicals, posters, brochures and flyers), merchandise and exhibition panels for audiences with and without a scientific background, which reinforces the ESO brand. Over 1180 pages of publications and merchandise were produced. Many of these are for the ESO Supernova and include products for younger generations.

Education and the ESO Supernova Planetarium & Visitor Centre

With the inauguration of the ESO Supernova Planetarium & Visitor Centre approaching in April 2018, interest continued, including requests from schools and companies to host events in the spectacular building.

The exhibition planner Design & Mehr and the Heidelberg Institute for Theoretical Studies (HITS) worked with ESO on the production of around 500 individual exhibition items in English and German. This included physical ESO exhibits that were organised and prepared for display together with partners, as well as scientific and educational guidance for the hands-on stations. ESO developed and delivered major parts of the exhibition and planetarium IT concept. Work progressed on the programme of activities, including promotional events for various target groups and an advertising plan.

Several partnerships were initiated, including: Bayern.de to promote the ESO Supernova to tourists; Bayerischer Rundfunk; educational partners, Evans & Sutherland; and several artists. The planning of the ESOshop in the ESO Supernova progressed with the selection of shop furniture and production of new merchandise. A point-of-sale system was procured with the Enterprise Resource Planning (ERP) team. Fundraising efforts continued, with US \$ 3500 secured from the international society for optics and

ESO 2017: News Popularity

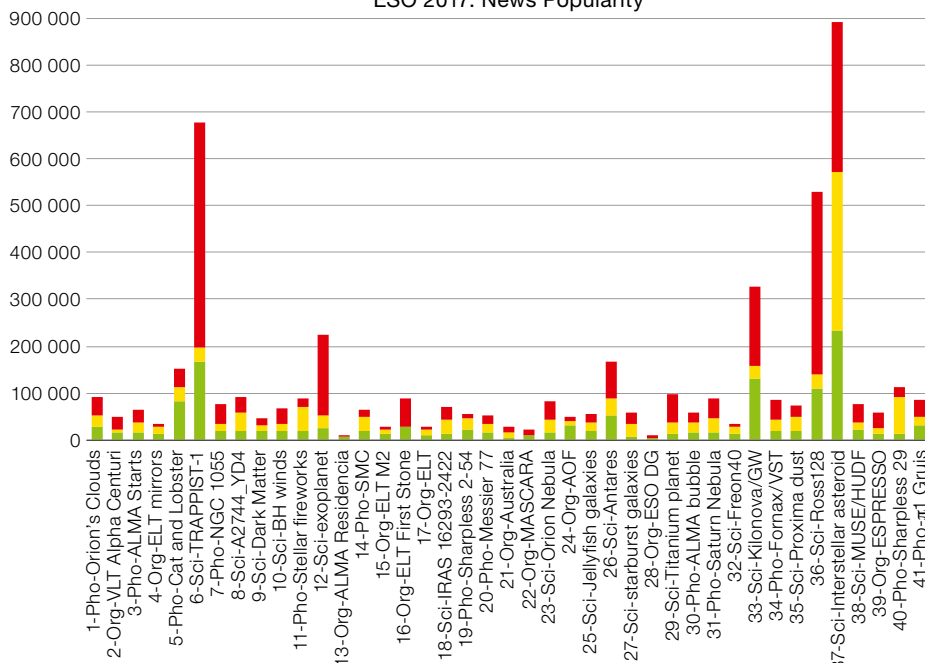

The relative popularity of the 41 ESO press releases in 2017. The most popular releases were the discovery of the seven TRAPPIST-1 planets (eso1706), the gravitational wave/kilonova event in October (eso1733), and in successive weeks in November, the planet Ross 128b (eso1736) and the interstellar asteroid 'Oumuamua (eso1737).

Google Analytics (green) measures the number of visitors to the news release web page on www.eso.org. Eurekalert (yellow) counts how many journalists followed the news release link on the Eurekalert website (a news aggregation and distribution site for journalists). Meltwater (red) is an electronic press clippings service; the metric is the number of online newspaper articles about a particular news release. These three metrics have widely different values and have been scaled to the range of Google Analytics values.



ESO education and Public Outreach Department staff looking at the VLT and the Milky Way at the first trial show of the ESO Supernova Planetarium.

photonics (SPIE) for a school work-shop focussing on optics and a pledge of US \$ 250 000 from the LOR foundation.

Construction culminated in the installation and commissioning of the planetarium system. This included the core projection system, the first of two real-time rendering computer clusters and peripheral systems for sound and lighting. The first show for an external audience was presented on 14 October 2017. ESO augmented the planetarium system with critical functions to improve its performance, reduce the manpower needs and integrate the system into the ESO framework. Additional improvements are planned for 2018.

To further exploit the possibilities that the planetarium offers, the “Data2Dome” system was implemented, through which it is possible to disseminate planetarium content developed by ESO to other planetariums worldwide. This can be seen as a multiplier for ESO’s planetarium-related outreach efforts. It is also a way to support planetariums in all ESO Member States (and beyond) with their mission to communicate astronomy to the public.

Over 290 school students from Germany, Switzerland and Italy, and 200 local kindergarten teachers participated in group

visits to the Headquarters in Garching. ESO-supported AstroCamps were held in Portugal and Italy, hosting 71 high school students from about 20 different countries. ESO also became a partner in the newly established “MINT-Region Münchner Umland” — an initiative that aims to bring young people closer to science and technology.

Audiovisuals

Extraordinary effort was invested into the production of HD, Ultra HD and full-dome audiovisuals in 2017, most of which will be used in the ESO Supernova. The successful ESOcast video podcast series has



Secondary school students attending AstroCamp 2017 in Northern Portugal.

been supplemented with a shorter series called ESOcast Light, which is directed at younger viewers.

The number of video views on social media and the iTunes rankings reflect an increasing popularity. In 2017, more efforts were invested in recording interesting explanatory interviews for use in multiple video products. New Ultra HD video compilations about the ELT First Stone ceremony and the VLT were produced as well as new trailers to showcase ALMA, La Silla and Paranal.

The online video and image archive represents an essential resource for ESO’s audiovisual content distribution and includes 3275 videos (including an increasing number of full-dome videos). Captions in multiple languages and an advanced metadata system facilitate integration with external platforms and allow quick and easy access. ESO distributes around one petabyte of audiovisuals per year — more than any other astronomy organisation in the world.

Web and software development

About a 100 info- and touch-screen applications for the ESO Supernova have been implemented. They follow the technological principles of the popular kiosk screens already in use at ESO, but include custom design and are interactive. Dedicated kiosk-style computers were installed for the “Our Place in Space”

Web visitors 2017: 6 484 797

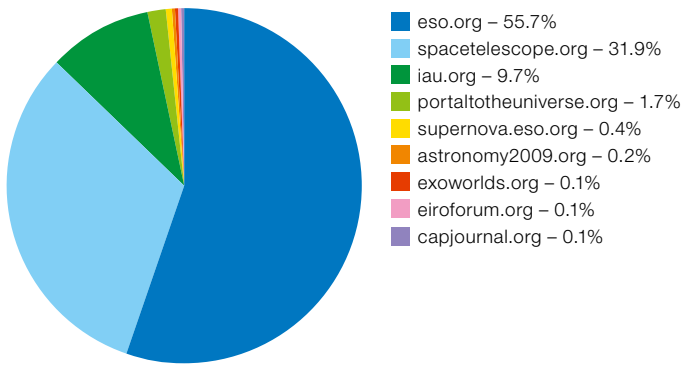

A chart showing the distribution of 6.5 million web visits in 2017 across the ESO, Hubble and IAU outreach websites.

Long-running partnerships (Photo NightScape Awards, Insight Astronomy Photographer of the Year, Photo Ambassadors, Music Ambassadors) continued to bring ESO visibility and support.

As in previous years, several print products were distributed worldwide (The Messenger, Annual Report, ELT brochure, Studentship poster, etc.). The address database continues to grow, incorporating groups such as Associations in Garching, Planetarium Influencers and Local Attractions.

ESA/Hubble exhibition in Venice, and standard kiosks were installed at all ESO sites, monitored centrally from Garching.

The ESOShop and HubbleShop payment system was replaced, with payments being handled offsite by a payment provider. Significant support was also given to the IAU in preparation for the IAU 2018 General Assembly.

A live streaming setup was tested and implemented for the gravitational wave press conference in October, using standard video conferencing equipment from the auditorium and streaming it to YouTube. This was the first time ESO streamed a press conference to the public live online.

Forum), products and services (ESOCast Light Series, ESOblog launch, Open House Day), partnerships (Insight Astronomy Photographer of the Year etc.), and also some one-off events (the arrival of the new Director General and assisting the volunteer-led group promoting Ireland's accession to ESO called #TimeToJoinESO). Support was also given to celebrate Denmark's 50th anniversary as an ESO Member State.

ESO's impact on social media also continued to grow. Around 40 000 individual messages were posted on social media, spreading the word about ESO results and milestones. A particular success was the gravitational wave campaign. The #ESOLive hashtag reached more than 5.3 million unique people and 2.1 million Twitter users per day over this period. An Instagram account was also opened in 2017 and grew at a faster rate than any other ESO social media channel.

Community coordination (strategy, promotion, distribution and social media)

A comprehensive strategy to promote ESO's studentship and fellowship programmes was devised and implemented. A strategy for event management at Headquarters, incorporating future ESO Supernova events, was also prepared. Strategic media support was given to special topics, such as the partnership with Australia.

Several promotional campaigns were organised, including for scientific results (for example, the gravitational wave press conference, TRAPPIST-1, and "Red Dots"), organisational milestones (for example, the ELT First Stone event, ELT contracts and the collaboration with the Breakthrough Foundation), industrial opportunities (the Big Science Business

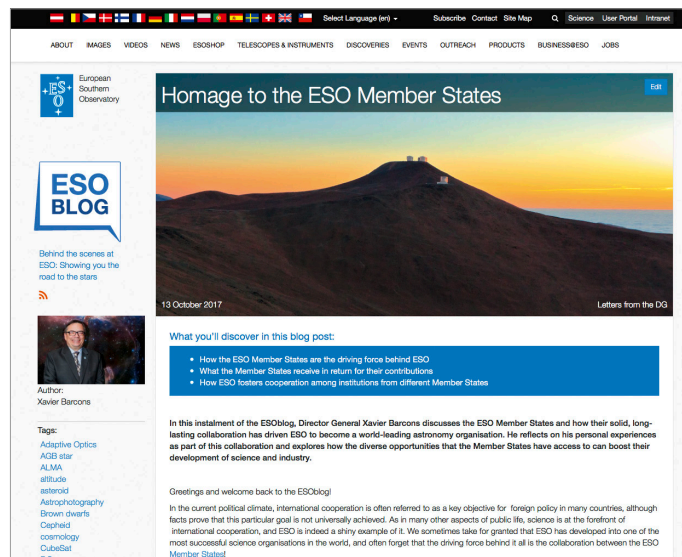
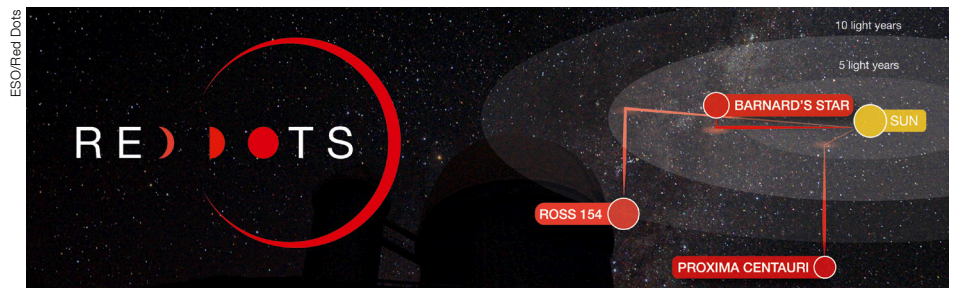

Above: The Red Dots campaign is using one of ESO's most successful exoplanet hunters, HARPS on the 3.6-metre telescope, to look for Earth-like planets around some of our nearest stars: Proxima Centauri, Barnard's Star and Ross 154.

Left: An ESOblog entry.

Exhibitions and events

ESO hosted a total of 42 events and exhibitions in 2017, including exhibitions in Germany (FORSCHA and Hannover Messe), Austria (Naturhistorisches Museum), Czech Republic (EWASS, scientists) and Denmark (Big Bang teachers conference). The ESO Open House Day 2017 in Garching was a great success with a record number of visitors (5600).

In Chile, event highlights included the ELT First Stone ceremony in May 2017, and the stunning audiovisual exhibition in the Via Suecia tunnel that was inaugurated in December 2017 in the busy metro station Los Leones in Santiago. ESO participated in major events in Chile including the Science Week (16 000 people) with interactive activities, and the *Festival Internacional de Innovación Social* (FiiS) in Antofagasta (20 000 people), which featured a videolink to Paranal, and included a talk in Santiago, as well as an ESO stand.

Media, VIP and weekend visits in Chile

Public weekend visits to La Silla and Paranal attracted 7936 people. 62 media groups visited Paranal, ALMA, APEX and La Silla during 2017. Several media delegations participated in the ELT First Stone Ceremony at Paranal, from Brazil, Chile, the Czech Republic, France, Germany, Italy, Poland and Spain. Among the prestigious media outlets hosted were Al Jazeera, the BBC, France 5, GEO Magazine, and Warner Bros, Portugal. A team from Česká televize, which covers the most influential topics in the Czech Republic, also visited ESO's facilities to celebrate the tenth anniversary of the Czech Republic's joining ESO.

ESO Science Outreach Network

ESO operates the ESO Science Outreach Network (ESON) to increase the visibility of ESO in Member States. Outreach specialists, press officers and educators act as direct local contacts with the media and organise the translation of ESO-related information into their local language. In total, ESON provided infor-

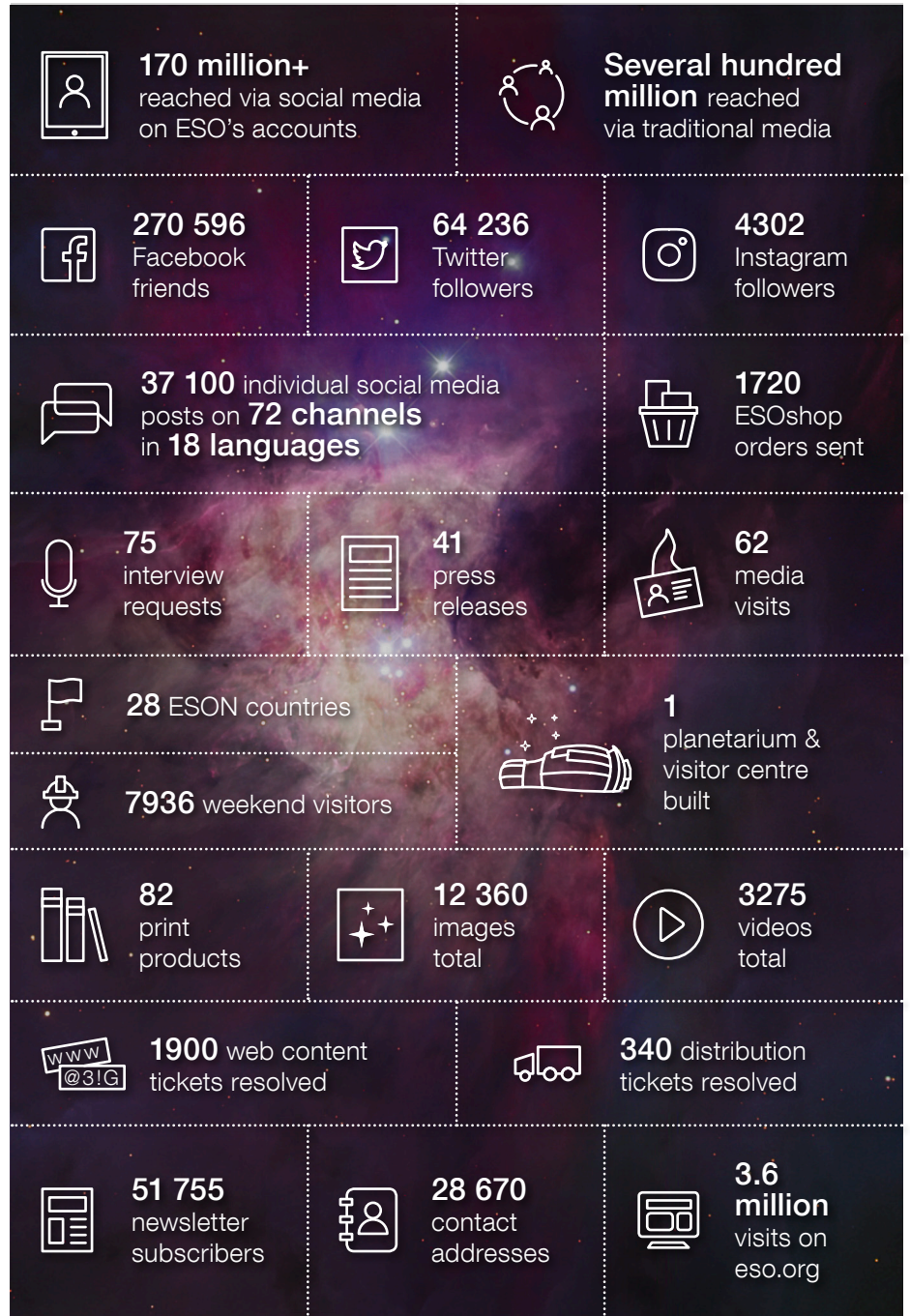

mation in 19 languages and operates in 28 countries including the 15 Member States — and it acquired its newest member, Hungary, in 2017. News products are translated from English into 18 different languages. In 2017, around 30% of the web pages viewed on eso.org were translated by ESON.

Some key figures related to ESO's education and outreach activities in 2017.





A stunning view of the stellar nursery Sharpless 29 taken using OmegaCAM on the VST.

Operations



La Silla Paranal Observatory

The Directorate of Operations is responsible for all activities related to science operations, including the preparation and execution of observing programmes, the operation of the La Silla Paranal Observatory (LPO) at its La Silla, Paranal and Chajnantor sites, and the delivery of raw and calibrated data. This role involves user support, dataflow management, operations technical support and the development and maintenance of a science archive provided by the Data Management and Operations (DMO) Division. The Science Archive Facility holds all the data obtained with ESO telescopes as well as highly processed, advanced products derived from them. In addition, the Directorate of Operations includes ESO's contribution to ALMA operations and development through the ESO ALMA Support Centre (EASC).

Operations

The VLT at Paranal operates with four 8.2-metre UTs and a suite of nine first-generation instruments and three of the four second-generation instruments. The AOF with four laser guide stars and a deformable secondary mirror has converted UT4 into an adaptive optics telescope that provides atmosphere-corrected images to its three instruments. The VLTI combines the light of either the four UTs or the four ATs to feed one of the three interferometric instruments with a coherent wavefront. The survey telescopes VISTA and VST are in regular operation.

On La Silla, the NTT and the ESO 3.6-metre telescope operate with an instrumentation suite of three instruments. The La Silla site also supports 11 hosted telescope projects, of which eight are currently operational.

The Observatory further provides operational support for APEX with its 12-metre sub-mm radio antenna located on the high plateau of Chajnantor at an altitude of 5100 metres; it has a suite of heterodyne and bolometer facility instruments as well as several visitor instruments.

For Periods 99 and 100 the scientific community submitted respectively 883 and 895 Phase 1 observing proposals for the LPO including APEX, proof of the continued high demand for the ESO facilities. About 87% of the proposals were for the Paranal site with VLT, VLTI, VST and VISTA.

The Observatory continued its efficient operation due to the high availability and low technical downtime of its telescopes and instruments — key elements for productive scientific observations. In 2017, 1903 nights were scheduled for scientific observations with the four UTs at the VLT and with the two major telescopes at La Silla. This is equivalent to about 87% of the total number of nights that are in principle available over the whole year. The remaining 13% were scheduled for planned engineering and maintenance activities to guarantee the continued high performance of the telescopes and instruments, and include time slots for commissioning new instruments and facilities. On UT4, 56 nights were invested in com-

missioning the MUSE and HAWK-I instruments with the AOF.

Of the available science time for the VLT, 4% was lost to technical problems and about 13% to adverse weather conditions. On La Silla bad weather accounted for losses of about 19% and technical problems for about 0.7%. VISTA delivered 287 nights of survey observations out of the 350 that were allocated and the VST delivered 276 nights of survey observations out of 349 scheduled. Both survey telescopes were affected by about 19% of weather losses. The technical losses of VISTA and VST were 2.2% and 2.1%, respectively; a reduction from previous years and significantly smaller than at the UTs.

The *El Niño* event from 2014 to 2016 was particularly strong and unexpectedly extended into 2017, leading to further exceptionally high weather losses. It culminated in May and June 2017 with 30–45% losses at the UTs and survey telescopes at Paranal and 40–55% at the La Silla telescopes. Another smaller peak was observed in September followed by a quick decline. As of October, the weather patterns had mostly returned to the seasonal normal.

Complementing regular VLT operations, the VLTI was scheduled for an additional 151 nights to execute scientific observations using baselines with either the UTs or the ATs. Of the scheduled VLTI science time, 5.8% was lost to technical problems, and 16% to bad weather. 78 engineering nights and 39 commissioning nights were invested during 2017 in the continued commissioning of the VLTI infrastructure and GRAVITY with the ATs and the UTs.

The combination of high operational efficiency, system reliability and availability for scientific observations of the La Silla and Paranal telescopes and instruments has again resulted in high scientific productivity. The statistical breakdown is presented in the Publication Digest (p. 27). Since starting operations in 1999 the VLT and VLTI have produced a total of 7733 publications and continued to add a further dozen every week. Interestingly, the veteran workhorse instruments FORS2 and the Ultraviolet and Visual Echelle Spectrograph (UVES) — both

The 3.6-metre telescope at La Silla.

commissioned alongside the VLT — continue to lead the publications statistics in 2017, with 133 and 106 publications, respectively (compared with 123 and 109 in 2016). These instruments are closely followed by X-shooter, VIMOS and MUSE, which produced 102, 88 and 77 publications, respectively (compared to 66, 75 and 47 in 2016).

Paranal Observatory

Infrastructure

The inauguration of the Armazones substation on 26 May 2017 was held on the periphery of the ELT First Stone Ceremony and marked an important milestone in the history of the Paranal Observatory: the arrival of the public electrical grid to the Paranal–Armazones site. The 66 kV line from the central Chilean electrical grid (SIC) arrives at the Armazones substation, located about halfway between Paranal and Armazones, and power is distributed to the two telescope sites via two dedicated 23 kV lines. During the construction of the 11 kilometre-long 23 kV line to Paranal, the preparations for the electrical grid at Paranal ran smoothly. These involved the installation of the custom-made transformers from 23 kV to 10 kV — to match the existing electrical system at Paranal — and the installation of a Power Conditioning System.

As for any other electrical grid, blackouts lasting from milliseconds to days, voltage spikes and frequency variations are to be expected. Special precautions had to be taken to prepare the sensitive equipment, including the telescopes, instruments and other equipment installed at Paranal. As the existing multi-fuel turbine and diesel generators could not cope with the blackout characteristics of an electrical grid, a new rotary uninterruptible power supply provided by the Belgian company Euro-Diesel was installed at Paranal’s power station. Spinning flywheels serve as an energy source during short outages and allow the connected diesel generator to start within seconds to cover longer outages. At the same time the inertia of the large rotating mass of the flywheel absorbs other grid fluctuations. Once the Power Conditioning System was successfully installed and commissioned, the whole Paranal Observatory was connect-



Inauguration of the Armazones substation, marking the arrival of the public electrical grid to Paranal and Armazones.

ed to the electrical grid on 7 December 2017 — about thirty years after construction of the Observatory began.

Telescopes and Instrumentation

By the end of 2016, the AOF on Yepun (UT4) had been successfully deployed and commissioned with its four Laser Guide Star Facility (4LGSF) and the Deformable Secondary Mirror (DSM) in non-adaptive mode together with the telescope, its three instruments, and the interferometer. This caused great excitement at the Observatory, and using the adaptive optics mode with MUSE and HAWK-I generated a lot of attention and expectation among the user community.

The next steps for the AOF were to commission the already installed GRound-layer Adaptive optics Assisted by Lasers (GRAAL) adaptive optics module for the HAWK-I instrument and to install and commission the Ground Atmospheric Layer Adaptive optiCs for Spectroscopic Imaging (GALACSI) adaptive optics module for the MUSE instrument. Both adaptive optics modules acquire the artificial laser guide stars produced by the 4LGSF and feed them to the wavefront sensing systems, which, with the help of a real-time computer, provide the required control signals to operate the 1170 actuators of the DSM in fully-adaptive mode at a loop frequency of about 1000 Hz. Both adaptive optics modules aim to correct for the lowest layers of the atmospheric turbulence encountered in the first several hundred metres above the telescope, providing instruments with improved image quality over the large field of view in line

with the HAWK-I and MUSE instruments. The astronomers call this the “seeing enhancer mode”.

HAWK-I is a cryogenic near-infrared wide-field imager installed at the Nasmyth A focus of UT4 with an on-sky field of view of 7.5×7.5 arcminutes and a pixel scale of 0.106 arcseconds that already matches the expected improved image quality to be provided by GRAAL with the AOF. During the commissioning of GRAAL with HAWK-I over the course of the year, it was confirmed that the full width at half maximum of the stellar images could be systematically reduced by 0.1 to 0.25 arcseconds, providing sharper images across the full field of view. MUSE is an integral field spectrograph located at the Nasmyth B focus of UT4. It has a modular structure composed of 24 identical integral field unit modules that, in the wide-field mode, sample a near-contiguous 1×1 arcminute field of view with a spatial resolution of 0.2 arcseconds. Spectrally, the instrument samples almost the full optical domain with a mean resolution of 3000. The GALACSI team managed to close the four loops of their adaptive optics system (one loop for each laser guide star) for the first time during the night of 22 March, and to feed the MUSE instrument with a ground-layer corrected field at visual wavelengths. In the meantime, both instruments underwent several additional commissioning and science verification runs to optimise and characterise their detailed performance and to demonstrate the scientific potential of these new modes; they are now offered to the community in regular science operation.

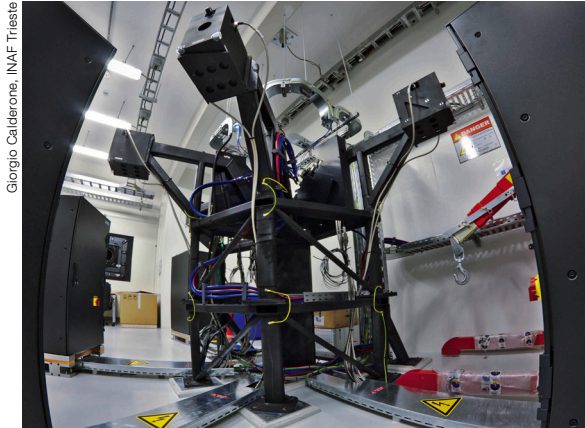

Giorgio Calderone, INAF Trieste

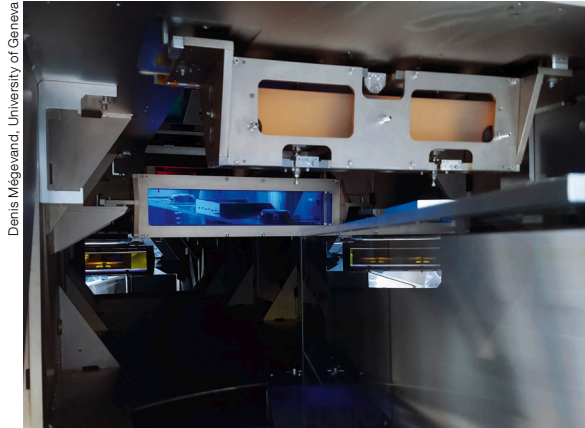

Denis Mégevand, University of Geneva

Far left: ESPRESSO's front-end.

Left: Inside the vacuum vessel, where the spectrographs are located to ensure stability.



Giorgio Calderone, INAF Trieste

ESPRESSO's first light team on the platform at Paranal.

ESPRESSO arrived at its final location at the incoherent focus of the VLT located in the Combined-Coudé Laboratory (CCL), where it was installed during September and October. ESPRESSO is a fibre-fed, cross-dispersed, high-resolution échelle spectrograph and can be considered a "super-HARPS". With a radial-velocity precision of better than 10 cm s^{-1} , Earth-mass planets in the habitable zone of a low mass star will be detectable. ESPRESSO uses light collected by any of the four UTs, but is also able to gather the light from all four UTs at once, theoretically resulting in a collecting area equivalent to a single telescope of 16 metres in diameter. This 4-UT mode will enable observations of very faint objects at high spectral resolution and makes ESPRESSO a powerful tool for measuring the variation of the physical constants across time and space and for the analysis of the chemical composition of stars in nearby galaxies.

The reassembly of the ESPRESSO spectrograph was completed by the end of October and first light with a single UT was achieved on 27 November.

While the first second-generation VLTI instrument GRAVITY carried out its first intensive six-month monitoring campaign of the Galactic Centre with the VLTI using the four UTs, the next second-generation VLTI instrument to be installed — MATISSE — passed its final tests at the Observatoire de la Côte d'Azur and was prepared for transportation to Chile and integration into the VLTI.

MATISSE is a four-way beam combiner, using the light collected by up to four ATs or UTs to perform both spectroscopic and imaging observations. In doing so, MATISSE possesses the theoretical imaging power of a telescope of up to



MATISSE Project / Y. Bresson

MATISSE in the laboratory at the Observatoire de la Côte d'Azur before being transported to Chile for integration into the VLTI.

200 m in diameter and the capability to produce stunningly detailed images in infrared light from the *L*-band to the *N*-band of the electromagnetic spectrum using aperture synthesis image reconstruction techniques. With these capabilities, the instrument is expected to contribute to fundamental research areas in astronomy such as the inner regions of discs around young stars where planets are forming, the study of stars at different stages of their lives, and the environment around black holes in active galactic nuclei.

After MATISSE had safely arrived at Paranal the whole instrument was re-integrated and re-tested in the New Integration Hall before being transferred to its final location in the VLT Laboratory where the integration with the rest of the VLT infrastructure continued. The first fringes using MATISSE and the four ATs are expected in 2018.

Science Operations

A new web-based Phase 2 tool (p2) and an updated version of a visitor observing tool have been deployed for the preparation of visitor mode observations as of Period 99. Key new features of these new tools include the real-time online creation and editing of observing blocks, which can then be seen instantly by the operation staff at the telescope and which are ready for execution. This replaces the check-in and check-out process necessary with the Phase 2 preparation tool p2pp. The extension of the p2 tool to service mode will take place gradually during Periods 101 and 102.

To support this more agile handling of observing preparation for visitor mode, Paranal Science Operations has deployed the Paranal Observatory Eavesdropping Mode since Period 99. This allows the scientists to participate remotely in the observing process by viewing all relevant instrument operation panels in real time via a web-based interface. The eavesdropping mode is mainly aimed at users of the “designated visitor mode”, who remotely participate in observations, but it is also available for users of time-critical service mode observations (for example, targets of opportunity) and for senior observers who may need to provide remote support for students during their observations.

Obsolescence Projects

The refurbishment of the 8-metre coating unit under contract to the Danish company Polyteknik AS allowed the recoating of all primary (M1) and tertiary (M3) mirrors of the UTs in 2017. After UT1 and UT3 had been recoated in August and December 2016, UT3 and UT4 followed as planned in April and August 2017, respectively. The coating of the M1 and M3 mirrors of the ATs will follow in 2018. Together with the replacement of all M4-8 optics of the AT coude optical trains that was carried out in 2017, all four ATs should be back in operation with optimal transmission by mid-2018.

Hosted Telescopes at Paranal

A second hosted telescope project, called the Search for habitable Planets EClipping ULtra-coOI Stars (SPECULOOS), is complementary to the already operational Next Generation Transit Survey (NGTS). SPECULOOS will carry out a photometric survey to look for Earth-sized planets transiting the brightest southern ultra-cool stars. The SPECULOOS observing facility consists of four 1-metre robotic telescopes equipped with CCD cameras operating in the very-near-infrared. All four domes and three of the four telescopes were successfully installed in 2017 and remote operation has started.

La Silla Observatory

La Silla Observatory continued to operate successfully according to its streamlined operations model. The La Silla 2010+ model supports the continued operation of the ESO 3.6-metre telescope with HARPS and the NTT with the Son of ISAAC (SOFI) instrument, EFOSC2 and visitor instruments.

Following a call for new instruments in 2014, the medium-resolution ($R = 5000$) optical and near-infrared (0.4–1.8 μm) spectrograph Son Of X-Shooter (SOXS) was selected as the future workhorse instrument at the NTT. SOXS particularly addresses the needs of the time-domain research community. In addition, the high-speed, triple-beam imager ULTRACAM was offered for up to 25% of the available time on the NTT in exchange for cash contributions towards NTT operations and for community access (up to 5% of

the time on the NTT). The Near Infra Red Planet Searcher (NIRPS) project will become the “red arm of HARPS” on the ESO 3.6-metre telescope, creating the most powerful optical to near-infrared precision radial-velocity machine in the southern hemisphere.

Whilst agreements were signed for the NIRPS and ULTRACAM instruments, negotiations with the SOXS consortium are still continuing in parallel to the instrument development. ULTRACAM is already operating at the NTT visitor focus, the NIRPS and SOXS instruments are expected to arrive in La Silla in 2019 and 2020, respectively. NIRPS will be integrated with HARPS and SOXS will replace SOFI and EFOSC2 on the NTT. This new instrument complement for La Silla provides exciting new prospects for the La Silla Observatory into the mid-2020s and has triggered the development of plans for the extension of the lifetime of the observatory’s infrastructure and its operation model that this implies.

La Silla further continued to support scientific projects at other hosted telescopes: the MPG/ESO 2.2-metre telescope; the Danish 1.54-metre telescope (Niels Bohr Institute of Copenhagen University, Denmark, and the Astronomical Institute of the Academy of Sciences of the Czech Republic); the Swiss 1.2-metre Leonhard Euler Telescope (Observatoire de Genève); the Rapid Eye Mount (REM; Italian National Institute for Astrophysics); the Télescope à Action Rapide pour les Objets Transitoires-South (TAROT-S; Centre National de la Recherche Scientifique, France); TRAPPIST (Université de Liège) and the ESO 1-metre telescope (Universidad Católica del Norte in collaboration with the Pontificia Universidad Católica de Chile).

The Multi-site All-Sky CAmERA (MASCARA) project of the Leiden Observatory completed construction and started operation during the year. This small planet hunter takes repeated measurements of the brightness of thousands of stars with its five off-the-shelf digital cameras and lenses. The main purpose of MASCARA is to find exoplanets around the brightest stars in the sky — currently not probed by either space or ground-

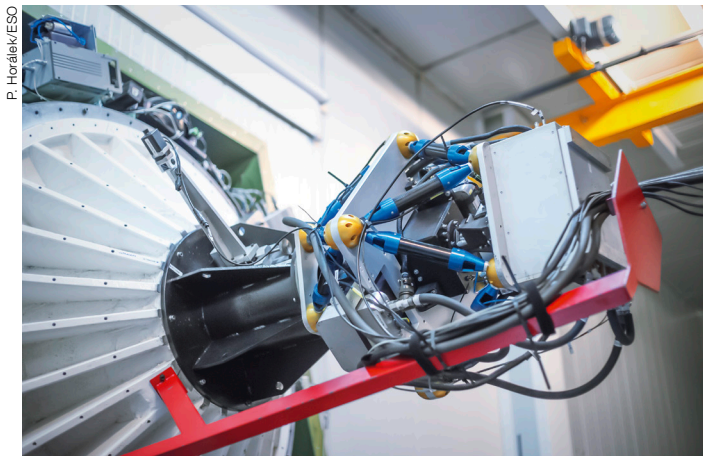

P. Horálek/ESO

ULTRACAM is an ultra fast camera capable of capturing some of the most rapid, transient astronomical events.



ESO/G. J. Tielens

The MASCARA planet-hunting system at La Silla.



ESO/Emmanuel Rimbaud

The three planet-hunting telescopes of the ExTrA project.

based surveys — by searching for the periodic dimming of a star's light as a planet crosses the stellar disc. The northern MASCARA station at La Palma in the Canary Islands has operated since early 2015. In 2017, it detected its first two “hot Jupiters” — large planets that are physically similar to Jupiter but that orbit very close to their parent star as indicated by short orbital periods of only a few hours, resulting in high surface temperatures. The prospects for its La Silla counterpart are similarly exciting.

A new telescope project by the Institut de Planétologie et d'Astrophysique de Grenoble (IPAG, France), called Exoplanets in Transit and their Atmospheres (ExTrA) completed construction in 2017 and science operations are expected to start in early 2018 for a period of five years. Hosting agreements for two new telescope projects, BlackGEM (Radboud University, Nijmegen and University of Leuven) and the Test-Bed Telescope (TBT; ESA) have been signed and construction is expected to start in the coming year.

APEX

APEX continued to operate its 12-metre antenna and its suite of heterodyne and bolometer facility instruments and visitor instruments in a quasi-continuous 24-hour operation mode, which maximises the exploitation of the exceptional conditions available at Chajnantor. In 2017, a total of 180 days and nights were scheduled for science observations with APEX out of which 158 could be used. This represented more than 3285 hours of on-sky science time up to 25 September, when science operations were suspended to upgrade the antenna, instruments and infrastructure. These activities are in preparation for the extension of the APEX operation agreement between 2018 and 2022.

The APEX project is a partnership between the Max-Planck-Institut für Radioastronomie (MPIfR, Bonn, Germany, 50% share), ESO (27% share) and the Onsala Space Observatory (OSO, Sweden, 23% share). After ten years of science operations APEX has produced over 600 science papers and over 16 000 citations, and remains a major catalyst to engage the ESO user community in submillimetre science. The instrumental capabilities are highly complementary with those of ALMA, thanks to its wide-field bolometer arrays, state-of-the-art heterodyne receivers and flexible observing model that allows optimal use of the best weather conditions at Chajnantor.

Given the continued success of the project, the three APEX partners agreed to extend the APEX project for five years from the beginning of 2018 until the end of 2022. On 5 May 2017 a new APEX agreement was signed, establishing a total additional investment of 18.5 million euros over the extension period under revised partner shares of 55% for MPIfR, 32% for ESO, and 13% for OSO as of 2018. The agreed investments include major upgrades of the antenna and the facility instrumentation.

One key requirement for APEX operation during the extension period up to 2022 was to relocate all science operation activities to the base at Sequitor and to cease science operation from Chajnantor. The remote science operation model was commissioned at the beginning of the year and regular operation started with the new observing season on 3 April 2017. The successful observing season had, however, to be shortened by three months to allow for the upgrade of the antenna and the infrastructure. By the end of the year, the company responsible for the antenna upgrade (VERTEX Antennentechnik GmbH, Germany) had replaced most of the aluminium panels that form the surface of the main reflector with new high-precision panels. The re-commissioning of the antenna and instruments is planned for the first quarter of 2018.

At the beginning of the year the APEX operation team noticed an unexplained continuous loss of diesel fuel from the APEX power station at Chajnantor and initiated a thorough investigation, which revealed a leak in the underground fuel line between diesel tank and generator that had deposited several thousand litres of diesel fuel into the ground near the power station. After the leak was repaired in early June the team's focus shifted towards locating and removing the diesel-contaminated soil. With the help of external experts, a decontamination strategy and plan were defined and are being implemented in parallel with the ongoing antenna upgrade activities at the high site.

The APEX telescope in the snow-covered Chajnantor landscape.

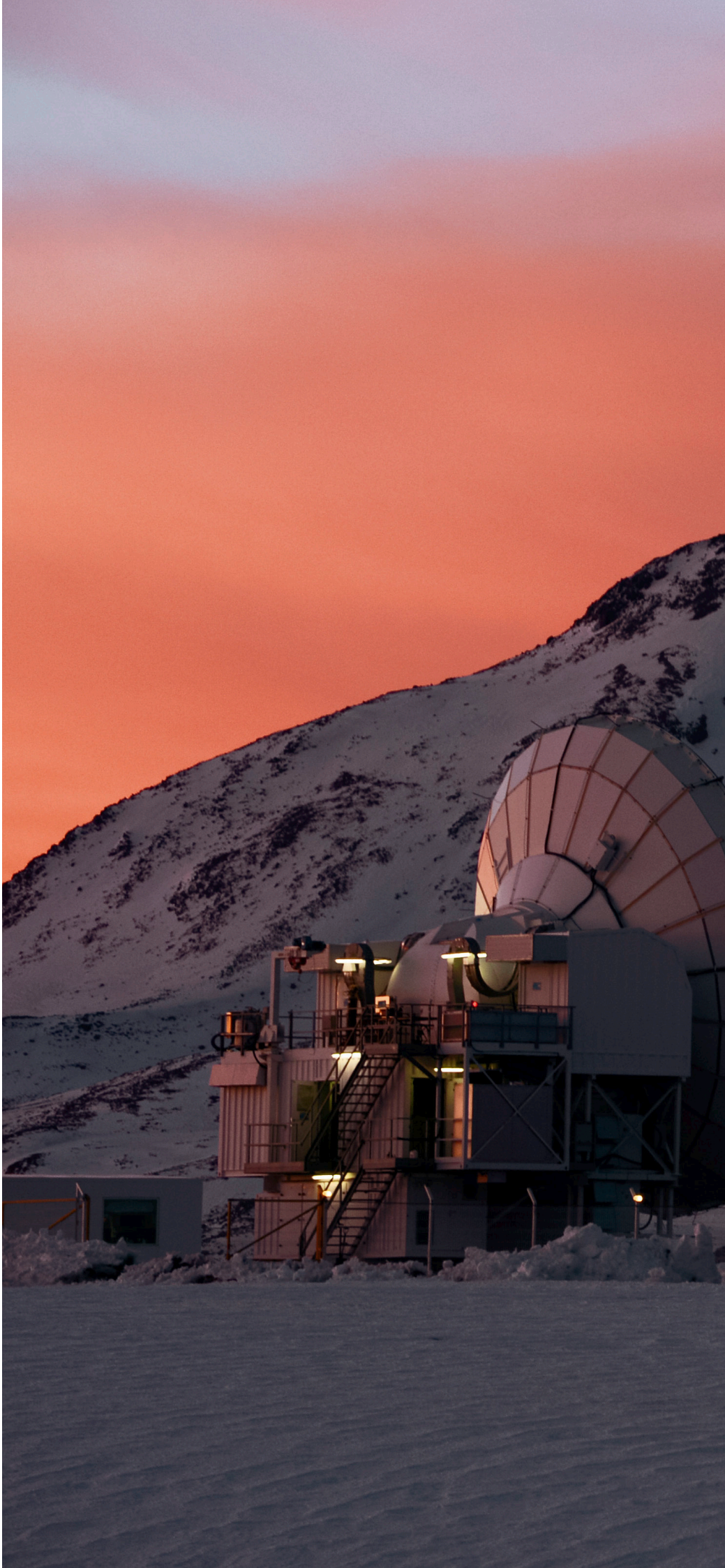







The Laser Guide Star Facility at the VLT.

Data Management and Operations

The Data Management and Operations Division is responsible for off-site operations and user support for the LPO. Integrated end-to-end operations enables the ESO community to use its facilities efficiently and to achieve a high scientific return. New instruments are steadily integrated into routine operations. The data obtained using ESO instruments constitute a valuable scientific resource and the ESO Science Archive Facility provides seamless access to its holdings. In 2017 significant improvements were made in the data-flow system to prepare for integrated VLT and ELT science operations, following a coherent development roadmap.

User Support

The User Support Department provides support to users of ESO's Paranal Observatory, assists the Science Operations Team at the Observatory in the efficient execution of Service Mode observations, defines user requirements and oversees the development and implementation of front-end observation tools. The department is also responsible for the ESO Users Committee (UC), and for the organisation of travel for astronomers visiting the observatory sites in Chile.

Support for the preparation of Phase 2 observations is a recurring core activity, and in 2017, the department assisted successful PIs with preparing their Service Mode observations for Periods 99 and 100, which had Phase 2 submission deadlines in February and August, respectively. Over the course of the year, Phase 2 and follow-up support was delivered for 937

Service Mode runs, counting runs scheduled within the two observing periods as well as Director's Discretionary Time runs (which are approved throughout the year). In addition, the Visiting Astronomer Travel Office within department organised travel for visiting astronomers for 593 runs. In total, the number of runs supported in both Service and Visitor Modes was comparable to that of previous years.

Staff in the User Support Department worked with colleagues across all directorates, contributing to a range of projects, some of which are providing operational improvements while others are developing new observational facilities. On the instrumentation side, this included participation in the commissioning and science verification of the AOF modes of MUSE and HAWK-I. In addition, there were activities related to the commissioning and consolidation of GRAVITY operations, preparations for ESPRESSO, and the review and development of plans for the operations support of the 4-metre Multi-Object Spectrograph Telescope (4MOST). Two new dataflow projects led by a project scientist from the User Support Department were initiated, involving the evolution of exposure time calculators and operations metrics. The User Support Department and the Directorate of Administration also worked together on integrating the Visiting Astronomer Travel workflows into ESO's ERP database.

In order to maintain efficient operation over 100 observing periods, while regularly adding new instruments and facilities, it is necessary to adapt tools and procedures. For the preparation of Visitor Mode

observations, a new web-based Phase 2 tool called "p2" and an updated visitor observing tool have been successfully deployed. The definition, implementation and testing of additional functionalities for the Service Mode version of p2 required a new release of this tool for Period 101 Phase 2 observations using UT2 and Survey Telescopes in December 2017. As well as developing updated Phase 2 tools, it is also necessary to address the obsolescence of older instrument-specific observing tools. The department developed installation packages for different operating systems and implemented them in the common ESO software repository that was originally developed for pipeline releases. Feedback is gathered annually via a questionnaire for Service Mode users on the effectiveness of the user support provided, and the 2017 survey confirmed the continued high level of user satisfaction.

Back-End Operations

ESO's mission includes providing the best science data for the astronomical community. Data generated directly by the telescopes, so-called "raw data", cannot be used immediately for scientific purposes, as they first have to be processed and calibrated. A continuing challenge for the exploitation of data from ESO's instru-

Some results from the 2017 Service Mode user satisfaction survey. The survey gathers user feedback on the level of support provided as well as satisfaction with Phase 2 tools. Reports from 2012 to 2017 are available online at: <http://www.eso.org/sci/observing/phase2/PostObservation/UserFeedback.html>

Overall, how satisfied are you with the support provided by the ESO User Support Department?

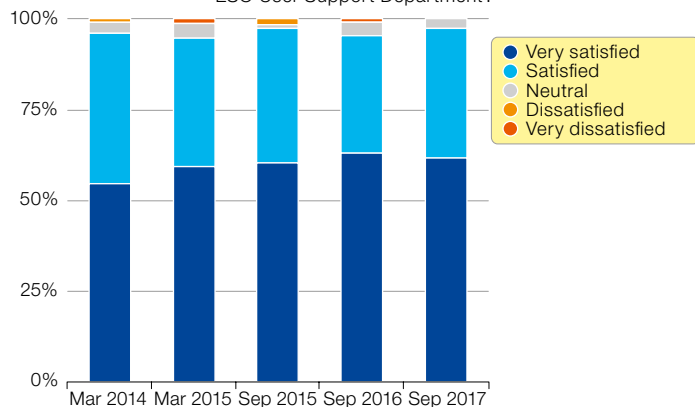

Global user satisfaction with tool functions provided

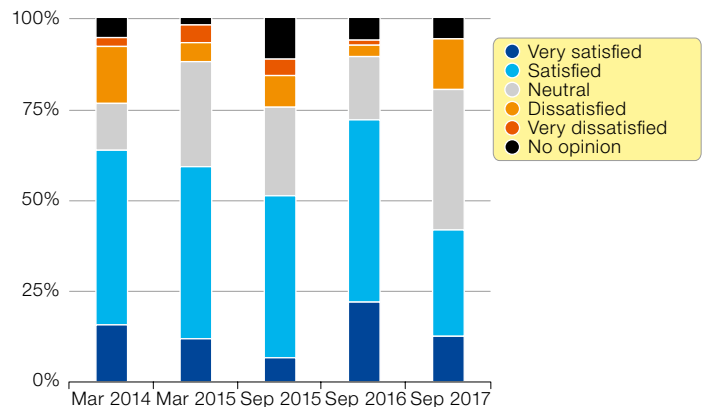

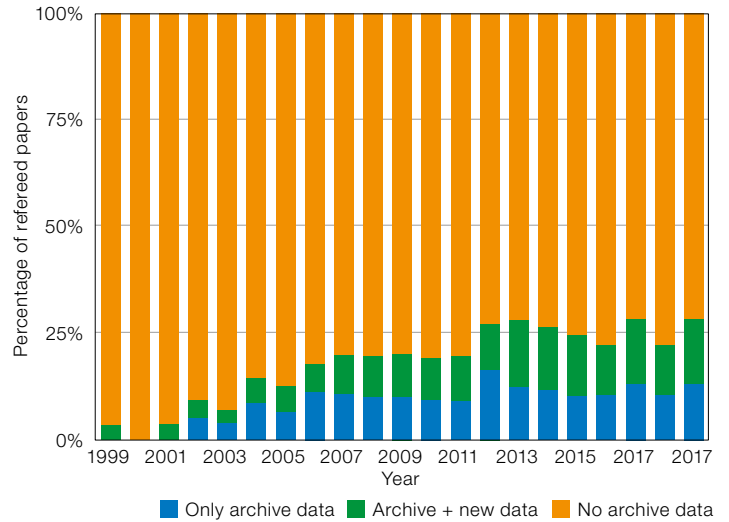
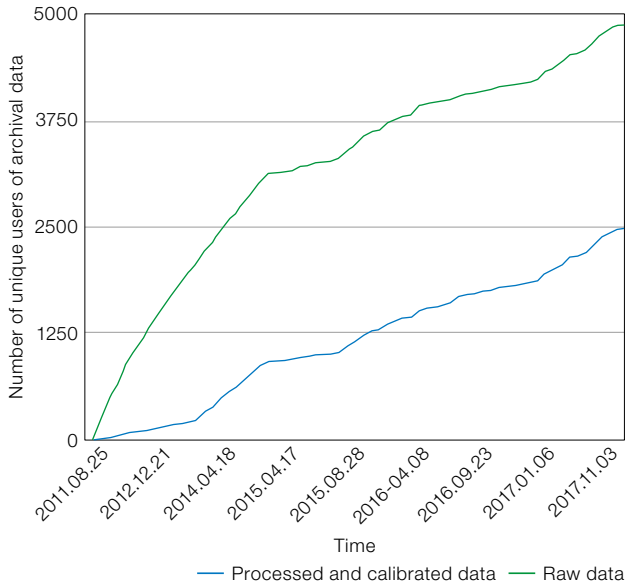

Left panel: The growth of the astronomical community using ESO archival data, showing only unique users. The start date of July 2011 marks the publication of the first processed data, and the number of users of raw data is normalised to that date. Right panel: The contribution of data from the ESO science archive to refereed papers using VLT data as a function of time.

ments arises from the steady increase in data volume and complexity, which can make this processing challenging.

ESO addresses this in two ways. First, by providing users with tools to process and calibrate data to science-grade levels. Second, by publishing processed and calibrated data that is already at science grade and thus ready for scientific exploitation. This alleviates the need for users to process data and expedites scientific analysis.

In addition to providing newly acquired data to those astronomers who were awarded telescope time, ESO develops and operates science archives. These store data and make them available for scientific exploitation by the wider community, often for science cases that are vastly different from those for which they were originally acquired.

The base of archival raw, processed and calibrated data has continued to steadily expand over the years and it now serves approximately 5000 users, a large fraction of the worldwide professional astronomical community (the IAU has just over 12 500 members). Almost 30% of the scientific output from ESO telescopes, as measured by publications in refereed journals, involves archival data.

The sustained success of the science archive over the years has prompted a

thorough review of its functionalities. This led to the development of a new web interface for the interactive discovery of the archive content. It features graphical views of the data, adaptive aggregations and previews to guide users through the complexity of the archive content so they can identify datasets suitable for their needs.

Astronomy is entering an era in which the answers to the most exciting science questions come from combining data across wavelengths, facilities and messengers (for example, optical observations with detections of gravitational waves or elementary particles like neutrinos or high-energy nuclei). In recognition of this fact, we have broadened access to ESO's data by adopting Virtual Observatory protocols. They enable complex queries to be carried out and provide direct access to data across multiple archives.

Adopting these standards ensures the accessibility of ESO data, particularly in the wider context of global open-access data.

Data flow projects

Data flow applications and end-to-end services for the VLT and ELT encompass the proposal submission system (Phase 1), observation specification and execution (Phase 2), archiving and retrieval of raw frames, data reduction, the ingestion of data products including catalogues (Phase 3), and the subsequent analysis and publication. The data flow services ESO provides ensure a high operational

Definition of an observing run with instrument-specific constraints in the new Phase 1 tool.

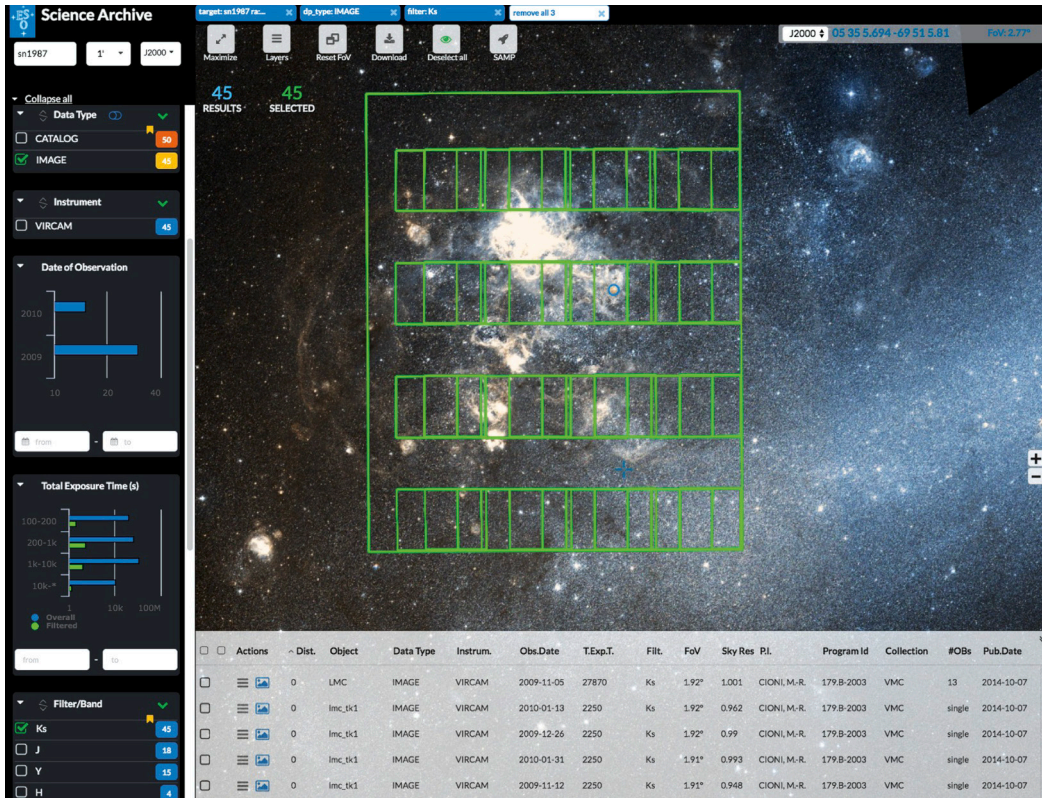

New ESO Archive Science Portal: a snapshot of the web interface.

efficiency, and value for the ESO user community. In 2017, a number of software solutions were updated and new ones developed, some examples of which are provided below.

The inception of the new Phase 1 proposal handling project called “p1” faced two major challenges in 2017: how to specify complex constraints and flexible requirements at key points of the submission cycle; and the conceptual integration of the new system with existing Phase 2 operations (including an interface with exposure time calculators). In order to provide users with a seamless experience throughout Phases 1 and 2, we carried out an in-depth analysis of requirements and prototyped a number of options. In the course of this harmonisation, web user interface design guidelines were produced, so that they could be reviewed and approved by the key stakeholders. In November 2017, a requirements readiness review was held and implementation of p1 is underway.

In April 2017, the web-based observation preparation application (p2) and its accompanying Phase 2 application

programming interface (API) were released, enabling Visitor Mode observations to be specified for all VLT instruments. Full Service Mode support for all UT2 and survey instruments, including the definition of scheduling constraints (to better define observing strategies), became operational in December 2017. It is now possible to define Observing Blocks (OBs), and detailed scheduling constraints with a web browser, as well as with tailored user-defined scripts that have been optimised for a particular observational strategy. Visitor Mode execution sequences can be defined and dynamically reprioritised throughout the observing period and changes show up almost in real time on Paranal. A comprehensive tutorial on how to programme OBs in Python was made available at <https://www.eso.org/copdemo>. The accompanying ESO internal observing tools for OB review and execution were also updated.

In its first release, the Archive Services Project aims to: provide previews of images and spectra as part of an archive search and to enable astronomical survey data to be visualised using the hierarchi-

cal progressive survey standard (HIPS); provide programmatic access to the ESO Science Archive Facility using the International Virtual Observatory Alliance’s Table Access Protocol, Simple Spectral Access Protocol and Data Link Protocol; and provide a modern web interface for archive searches, incremental search refinement and interactive archive content exploration (Figure 5). After an analysis of the detailed requirements, the project implementation plan was produced and approved in July. The implementation of all features progressed very well throughout the year and the first operational release is planned for March 2018.

Further data flow activities in 2017 included: the release of the unified target acquisition preparation tool for all ESO instruments (GuideCamTool version 2.1), which provides full support for the adaptive optics modes of MUSE; the release of Reflex 2.8 with various new features and improvements; live correlation plots in the ambient site monitor (ASM); and the extension of the Night Log Tool as well as the Phase 1 long-term scheduling software (TaToo) and the observing tool to support ESPRESSO’s 1-UT mode.

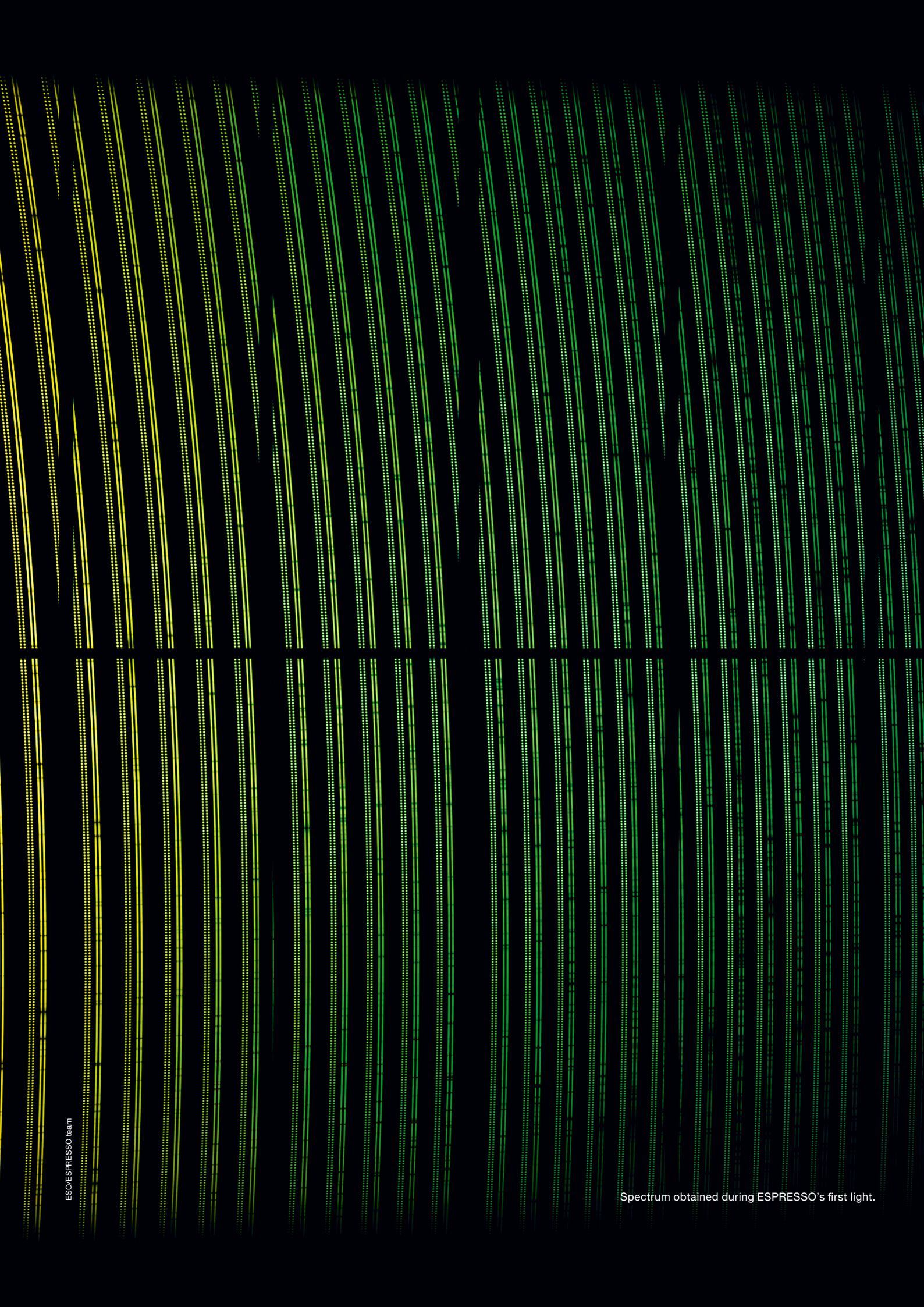

ESO/ESPRESSO team

Spectrum obtained during ESPRESSO's first light.



ALMA is a large interferometer for radio wavelengths ranging from 0.3 to 9.6 millimetres. It was constructed between 1999 and 2014 via an international collaboration between Europe, North America and East Asia in cooperation with the Republic of Chile. The Joint ALMA Observatory (JAO) comprises 66 high-precision antennas with state-of-the-art receivers located on the Chajnantor Plateau, 5000 metres above sea level in the district of San Pedro de Atacama in the Chilean Andes. The 12-metre diameter antennas can be configured to encompass baselines ranging from 15 metres to 16 kilometres. A resolution of 0.005 arcseconds can be achieved at the highest frequencies; this is a factor of ten higher than that possible with the NASA/ESA Hubble Space Telescope at optical wavelengths.

Joint ALMA Observatory

ALMA operations and science

During Cycle 4 in 2017, ALMA continued to prioritise data processing and delivery throughput, improving both the quality and timeliness of the data products. The scope of the so-called standard modes, which qualify for the larger portion of the total available observing time, was expanded to include long baselines. This allows the scientific community to apply for more high-resolution observations and enables large programmes at long baselines.

During Cycle 4, the typical antenna numbers per execution and the productive time available on sky expanded. Through optimisation, 92.5% of 12-metre array observations used at least 40 antennas, with typical observations using 43. However, there were also some significant challenges. Approximately 12% of the time allocation during the year was lost to two major snowstorms in May and June. It took six weeks to clear the antennas for operations, which delayed the planned reconfiguration effort. This experience dramatically exposed the difficulty of observing in extended configurations during the winter.

ALMA joined the GMVA and the EHT for the first time, for a detailed study of — among other things — the supermassive



ALMA (ESO/NAO/JRAO)

black hole at the centre of the Milky Way. These Earth-sized telescopes are made possible by international collaborations involving independent radio telescopes. The GMVA will derive the properties of the accretion and outflow in the immediate surroundings of the Galactic Centre, while the EHT will aim to image the shadow of the black hole's event horizon for the first time.

The call for proposals for Cycle 5 established new records for the number of proposals received and hours requested, which led to an oversubscription factor of 4, and even higher for the European applications (see p. 25 for more details). In preparation for Cycle 6, significant enhancements were achieved regarding the high-frequency performance of

Aerial view of the Chajnantor plateau in Chile's Atacama desert, which is host to ALMA's 66 high-precision antennas.

ALMA. The configuration schedule includes more compact configurations during the southern winter, allowing observations during the driest weather at baselines not dominated by atmospheric turbulence. ALMA was also upgraded to utilise all the available bandwidth for the two highest-frequency bands, effectively doubling the bandwidth over previous cycles. Finally, the antenna surfaces, which had been optimised for temperatures around 0 degrees Celsius, were modified to optimise their performance at

ALMA antennas during a snowstorm on the Chajnantor Plateau.



J. C. Rojas/ESO



ICARE 2017 ceremony where ALMA received an award for its contribution to supporting growth in Chile.

–10 degrees Celsius, the temperature at which most high-frequency weather occurs.

Looking towards the future, ALMA gathered input from several public and advisory forums so as to update the science goals for the use of the ALMA Development Fund over the next 10–15 years. ALMA will soon begin to map out a coordinated phase of upgrades to achieve those goals. The new science goals and top technical directions will be made public in 2018.

ALMA: Beyond science

In 2017, ALMA received two Chilean awards, the Avonni award from the ForInnovación foundation to “Sounds of the Universe” (awarded for musical creations based on ALMA observations), and another from the Chilean business organisation ICARE for its contribution to business development through excellence and international collaboration.

The global Astronomical Data Analysis Software & Systems (ADASS) conference was held in Chile for the first time; it was organised by ALMA, ESO and the Universidad Técnica Federico Santa María (UTFSM) and provided a showcase for the broader impact of observatories in Chile.

Finally, the outstanding global interest generated by ALMA resulted in almost 7000 visitors — with over 20 nationalities — to the site during 2017; more than half of these were public visits. ALMA's profile was further enhanced through 38 media visits, 52 educational visits, and seven artistic visits, bringing ALMA to the attention of the public worldwide.

New ALMA Director elected

In July 2017, the international governing board of ALMA selected Sean Dougherty as the new ALMA Director. Sean has been Director at the Dominion Radio Astrophysical Observatory and Programme Director for the radio astronomy programme for the National Research Council in Canada since 2008. He has actively participated in Canada's contributions to many radio astronomy facilities in the world, and has also collaborated on many projects with the NRAO, Square Kilometre Array (SKA), National Science Foundation (NSF), and several other scientific organisations, including ALMA.

Enhanced living conditions at the ALMA site

Many ALMA staff spend nearly half of the year living on site, so it is essential to have a comfortable place for them to



The new ALMA Director Sean Dougherty.

sleep and eat with appropriate recreation facilities where staff members can gather. The staff moved into the new Residencia, which was delivered by ESO, in early August 2017, marking a monumental milestone for the enhancement of the living conditions at the site. The main building, which includes a pool and a gym, opened for activities during 2017. The dining area will be opened for use by early 2018.

An indoor sports facility (“multicancha”) at the ALMA Operation Support Facility was donated by the North American partner, NSF, with NRAO, via a one-off funding contribution. The new building should be delivered by mid-2019, and it will represent one of the most anticipated enhancements of the onsite living conditions.

European ALMA Support Centre

The ESO ALMA Support Centre (EASC) is ESO's offsite operations unit for ALMA and a division in the Directorate of Operations. It is one of the three ALMA support centres, based at the three ALMA Executives in Europe, North America and East Asia, which support the Joint ALMA Observatory (JAO) and ALMA onsite operation. EASC comprises the ALMA Regional Centre (ARC), ALMA offsite hardware and software maintenance and



P. Carrillo- ALMA (ESO/NAOJ/NRAO)

with the user community and are based within observatories and universities with active research environments. In addition to providing face-to-face user support, the ARC nodes organise events and provide scientists who serve as points of contact for ALMA observing programmes. These scientists are incorporated in the quality assurance procedure and are also involved in ALMA commissioning activities and work to enhance ALMA's capabilities.

The central coordinating ARC is a department of EASC and works closely with the ALMA Observatory. Together with the other ALMA executives, the ARC department forms an integral part of the science operations team. It also hosts subsystem scientists, who provide scientific guidance in the development of several key software components. The ARC also contributes to astronomer-on-duty shifts at the ALMA site in Chile.



ALMA (ESO/NAOJ/NRAO)

Above: The ALMA Residencia in the moonlight.

Left: The new ALMA Residencia handover celebration was attended by the ALMA Board and the Directors of the three executives — ESO, NAOJ and NRAO.

In 2017, there was a major upgrade of the global quality assurance and data reduction workflow at ALMA. The ARC played a significant role in designing and implementing this new workflow, which was designed to make the PI data flow to end-users faster and more efficient. The ARC department started to execute the imaging pipeline for ESO-supported projects in addition to the calibration pipeline that was already in use. By the end of 2017, about 80% of the datasets were pipeline-calibrated and 60% were pipeline-imaged.

The ARC supported the call for proposals and proposal submission processes for Cycle 5, which resulted in 695 observing projects being submitted by users in the ESO Member States. Together with the other regions, these projects were competing for 4000 hours of observing time on the main array and 3000 hours on the 7-metre array. After the completion of the proposal review process in July, ALMA Contact Scientists — mostly at the ARC nodes — and staff in the ARC's Phase 2 group assisted with adding these projects to the observing queue. In total, 290 Cycle 5 projects (including three Large Projects) are scheduled for observing. In addition to the above activities, the ARC supported an extra call for proposals for the 7-metre array.

development support, and ALMA science and outreach.

The high-level scientific representation and scientific guidance of the European ALMA project are provided by the European Programme Scientist, who collaborates closely with the VLT and ELT Programme Scientists to exploit the scientific synergies with ESO's other major programmes. EASC is the face of ALMA for the European scientific community and the international ALMA partners for ALMA operations. EASC plays an important part in ALMA's success, both in terms of its performance as a scientific instrument and for ESO as a partner in the ALMA project. Wolfgang Wild, who had been leading the ALMA efforts at ESO for a decade, departed in mid-2017 to become

CTA Project Manager. Leonardo Testi was recruited to take over the responsibility as Head of EASC from 1 January 2018.

The ALMA Regional Centre in Europe

The ARC provides the interface between the European user community and the ALMA Observatory in Chile. The ARC department is part of a distributed network of ARC nodes, which are located in the Czech Republic, France, Germany, Italy, the Netherlands, Sweden and the United Kingdom, and also includes a centre of expertise in Portugal. This network continues to be a very successful model for providing user support to European users; the nodes have strong ties



The ALMA front-end laboratory at the OSF.



The ALMA correlator at the Array Operations Site.

ALMA Technical Team

The ALMA Technical Team (ATT) in EASC is responsible for offsite technical support and hardware development projects. In 2017, the ATT provided support, specific knowledge and assistance to the ALMA Observatory in the areas of antennas, antenna transporters, front ends, calibration devices, water vapour radiometers, the back end, the correlator, and site infrastructure (in particular the antenna stations and the power generation and distribution system). In addition, ATT staff manage the hardware development projects (currently for Band 5) and contribute to development studies.

The ATT at ESO is the European part of the ALMA-wide Integrated Engineering Team, IET (also called IET-EU). It has provided remote (offsite) maintenance and on-site support for the ESO deliverables throughout 2017, including the following:

- In the antenna area, Tier 3 maintenance tasks were taken care of, including missions to the site as necessary. A maintenance script for the remote auto-lubrication of the hexapod struts was developed and distributed to JAO for use. The maintenance contract for the Antenna Control Unit Software was awarded. A programme to upgrade the obsolete Antenna Drive system electronics was initiated. An external ALMA Antenna Maintenance Review was

called by the ALMA board and held at the Operations Support Facility (OSF) in September.

- In the front end, a reliability issue with the cryogenic cold heads detected by JAO in 2016 was addressed, and an onsite mission was conducted to review the audit of the JAO maintenance facilities and procedures performed by the manufacturer of the cold heads.
- A 3-year contract for Tier 3 maintenance and the obsolescence recovery programme of the Water Vapour Radiometer was awarded. Additional contracts placed by the ATT in Europe were for the offsite maintenance of digitisers, digitiser clocks and the correlator tunable filters, and for the offsite maintenance of the Band 5 Bias Modules and

Cartridge Power Distribution System (CPDS) cards.

- Follow-up and progress meetings of the action items set at the transporter review were organised by the ATT jointly with JAO.
- In the power generation and distribution area, technical and procurement support was provided as necessary.

ALMA Computing

The ALMA Computing Team at EASC, including partner institutes in Europe, develops and maintains ALMA software subsystems in collaboration with similarly sized teams in East Asia, North America and Chile. The software tools for prepar-

Otto, one of the two transporters used by ALMA to move its antennas across the Chajnantor Plateau.



Willem-Jan Vreeiling (SRON)



The cold cartridge assembly production team at NOVA (including Pavel Yagoubov from ESO).

ALMA development

The ALMA partnership plans continuous upgrades and the development of new software, front ends (for example, additional receiver bands) and other hardware or system capabilities during the operations phase. In 2017, two projects were (co-)funded by ESO: completing the production of the Band 5 cartridges; and the initial development of the ALMA Integrated Alarm System.

In 2017 the production of the Band 5 receivers was completed. The cold cartridge assemblies were designed and produced by a European consortium of the Netherlands Research School for Astronomy (NOVA) and the Group for Advanced Receiver Development (GARD) at Chalmers University in Sweden. The warm cartridge assemblies were delivered by NRAO. ESO is also responsible for supplying all of the required auxiliary equipment for Band 5 receivers.

Oscar Mattsson



The cold cartridge assembly production team at GARD.

The integration of Band 5 cartridges into front ends and ALMA antennas, which began in May 2015, is progressing and is expected to be completed by March 2018. Science verification observations were performed with the Band 5 receivers in 2016; this new capability was offered for observations as part of the Cycle 5 ALMA Call for Proposals in 2017 and the first datasets were acquired with the 7-metre dishes of the Atacama Compact Array on 25 December 2017. Thanks to careful end-to-end testing, observations went very smoothly and the dataset was ready to be released to the PI in early January 2018.

L. Testi

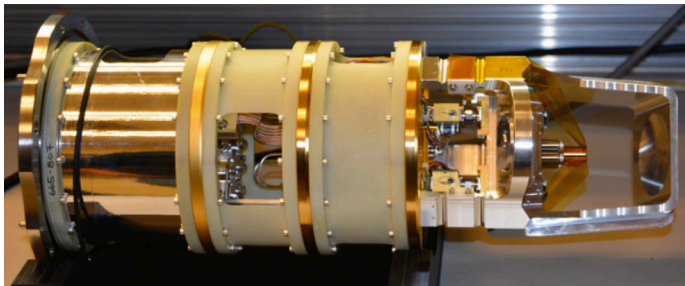

ALMA Band 5 receiver cold cartridge assembly at the OSF, ready for integration into an ALMA Front End.

The detailed design of the ALMA Integrated Alarm System was completed and successfully reviewed. The actual development of the software system is progressing in collaboration with INRIA Chile and with the CTA observatory, which is also interested in developing a similar system.

Development studies

Major progress was achieved on various aspects of the ESO ALMA upgrade studies in 2017.

Solar observing modes: The study was successfully completed in 2017, and the

ing observing projects and operating the antenna array are mature and stable. They have undergone regular maintenance and improvements, as well as updates to support additional observing modes.

The development focus has very much been on numerous software tools to support the automated data reduction and imaging pipeline, which has entered into routine operation. The shift from a JAO-centric data processing model to a distributed one, including the three ARCs, has made it necessary to redefine the entire post-observation workflow. This included major updates to many distributed components, ranging from

data quality assurance and archive interfaces to integrated reporting tools.

Another important change in 2017 was the transition of the Telescope Calibration subsystem from the Institut de Radioastronomie Millimétrique (IRAM; France) to ESO. This subsystem is responsible for performing near-real-time calibrations for immediate feedback to the control software, using observing data as well as environmental information.

The ALMA Computing Team was fully staffed for most of the year, using a combination of ESO staff, contractors and staff from external science institutes.



Participants at the Band 5 science workshop, held at ESO's Headquarters in Garching.

final report was published as an ALMA memo and as a Messenger article. Discussions regarding the possibility of investigating the potential of high-cadence solar imaging were also held, leading to the finalisation of an agreement for a potential study starting in 2018.

Data analysis software: The study aimed at delivering the interoperability of the Common Astronomy Software Applications (CASA) software packages eXtended CASA Line Analysis Software Suite (XCLASS) and Adaptable Radiative Transfer Innovations for Submillimetre Telescopes (ARTIST) was completed and reviewed. Some components exceeded the original goals and the software is now fully available at: <https://xclass.astro.uni-koeln.de/>.

Next generation digitisers: In a study led by the Laboratoire d'Astrophysique de Bordeaux at the University of Bordeaux a new generation of digitisers for ALMA are being designed and tested. The first phase of this study was successfully completed and reviewed. The study is now entering the phase of detailed design of the components required to extend the bandwidth of the ALMA system.

Band 2–3 prototype: In 2017, ESO continued to support development studies on the science case and technical feasibility of a receiver covering Bands 2 and 3 (67–116 GHz, Band 2+3) with 16 GHz bandwidth per polarisation. The ongoing study, which was started in 2014, is being carried out by a consortium of several European institutes, ESO, Universidad de Chile and NAOJ. A successful PDR was held in Garching at the end of November

2017, where the receiver prototype design was reviewed with a very positive outcome. The full test of the prototype optical components (feed horn, lens and Ortho-Mode Transducer) demonstrated that such a system would meet all ALMA requirements for the optics over the wider band with no compromises in performance over a design optimised for Band 2.

Test results for monolithic microwave integrated circuit (MMIC) amplifiers designed by the University of Manchester in collaboration with the Cahill Radio Astronomy Lab (USA), and using the Northrop Grumman Corporation 30-nm gate length process are extremely promising, with noise temperatures measured at less than 28 K over more than 80% of the wide band and little dependence on frequency. There is also a commercial alternative, from the Low Noise Factory (Sweden), with comparable performance. The use of materials different from high-density polyethylene (HDPE) for warm lenses was also investigated in order to improve the receiver performance. A silicon lens was produced and tested with encouraging results, leading to the preparation of a specific development project to optimise the warm lenses for ALMA low frequency receivers.

Several other studies were also initiated in 2017 as a result of the 2016 Call for Studies, including the investigation of the future evolution of the ALMA Observing Tool, several developments in the area of receiver upgrades, and improvements in the archive content by reprocessing past ALMA Cycles.

ALMA antennas under the Milky Way.





Programmes



Instrumentation for the La Silla Paranal Observatory

Without a doubt, the highlight for the ELT programme was the approval by the ESO Council that the ELT will be delivered with the full primary mirror.

In the Paranal Instrumentation programme, a plethora of instruments are at various stages of integration and commissioning on Paranal including:

- GRAVITY started to observe the Galactic Centre in parallel with both its commissioning programme and routine off-axis mode observations.
- AOF commissioning has continued in spectacular form, leading to the full qualification and validation of the wide-field mode and the ground-layer adaptive optics mode.
- ESPRESSO was granted Provisional Acceptance Europe (PAE) in August 2017 and first light was obtained in December with one UT, immediately demonstrating the huge gain from moving to an 8-metre telescope.
- MATISSE passed PAE in September and has been re-integrated into the VLT laboratory on Paranal.

The Technology Development Programme made substantial progress on the development of key adaptive optics components for the ELT. Work also continued on the New Earths in the Alpha Centauri Region (NEAR) experiment to search for habitable planets around Alpha Centauri. Meanwhile, development continues in a number of important areas, including the new detector test system the Facility for Infrared Array Testing (FIAT), laser guide stars, high-order deformable mirrors, low-noise amplifiers for ALMA, high contrast techniques and infrared avalanche detectors.

The inside of an 8.2-metre Unit Telescope.

Paranal instrument commissioning

2017 marked a very intense year for the Paranal Instrumentation Programme. GRAVITY is a second-generation VLT instrument that combines signals from four telescopes in the *K*-band and enables spectroscopic imaging. It will measure the astrometric separations of objects located within the 2-arcsecond field of view of the VLT with a precision of 10 micro-arcseconds. In 2017, the commissioning of the astrometric mode of GRAVITY continued, together with regular operations of the instrument with the Coudé Infrared Adaptive Optics (CIAO) off-axis mode, the CIAO on-axis mode having already been commissioned. A detailed description of commissioning and the first observations, including Science Verification and Galactic Centre observations, was published in the December issue of *The Messenger* (Volume 170).

Another second-generation instrument, ESPRESSO, was granted PAE in August 2017. ESPRESSO is contained in a large vacuum vessel for increased stability and is equipped with a reference source to characterise any instrumental drifts simultaneously with science observations, following the same concept as HARPS. ESPRESSO can observe with any of the UTs, or with all four UTs together (with a collecting power equivalent to a 16-metre telescope). For this purpose, the project included the procurement and installation of the four coudé trains from the UTs to the coudé laboratory. All coudé trains

were commissioned in 2017. ESPRESSO operations are running smoothly and the instrument is being delivered with its own pipeline and data analysis software. After PAE, ESPRESSO was shipped and integrated in the combined coudé laboratory. PAE was awarded without the red camera owing to its late delivery by the manufacturer, so it had to be integrated at Paranal. ESPRESSO successfully completed its first commissioning run, and first light with one UT was obtained in December 2017. ESPRESSO includes several technical innovations for ESO, such as the heavy use of optical anamorphism, pupil slicing, the largest monolithic (9k × 9k) detectors, and an LFC for extremely accurate and precise calibrations.

The second generation VLT instrument MATISSE will provide closure-phase imaging and spectroscopy at interferometric resolution of a wide range of targets, including asteroids, young stellar objects and AGN. The PAE process proceeded as planned in August and was successfully concluded despite some limitations due to the air-conditioning system, which damaged some of the detector boards, making some of the final tests challenging. PAE was granted in September, followed by instrument shipment and re-integration of the two cryogenic vessels (*L-M*- and *N*-bands respectively)

Artist's impression showing how the light collected by all four VLT Unit Telescopes is combined in the ESPRESSO instrument, located under the VLT platform.

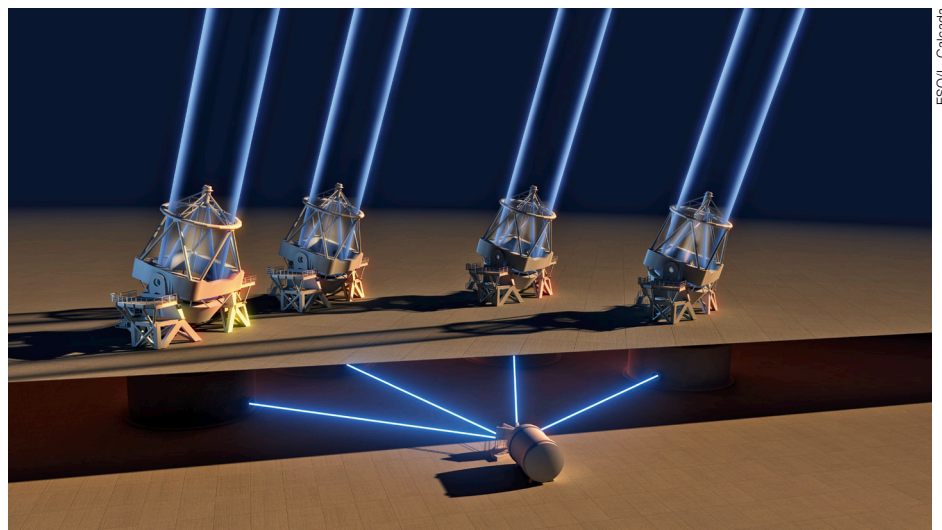

ESO/L. Calçada

in the New Integration Hall at Paranal. From the New Integration Hall, they were transported into the VLTI laboratory — which had been re-shaped to host MATISSE. The vessels then had the necessary feeding optics installed and re-integrated with the warm optics, which interfaces the vessels to the VLTI system. The two cryostats were successfully cooled. The first fringes are planned for February 2018, and the first commissioning run with the Auxiliary Telescopes is expected in March.

Instrument upgrades

X-shooter is a very popular instrument, but for some time its atmospheric dispersion compensators (ADCs) were inoperable because of mechanical instabilities. The project team made several interventions to fix the four ADCs with new drives and to recommission the instrument. After the first intervention one of the systems behaved erratically and had to be fixed. The project has now been successfully completed and X-shooter has been offered to the users with working ADCs.

A small second project that was finalised in 2017 was the so-called “NACO survival” project. NACO was originally supposed to be decommissioned after its removal from UT4, but it was decided to keep it in operation to continue the monitoring of the Galactic Centre and to support observations in 2017 and 2018. The re-installation of NACO carried some risks because of the critical state of three major components: the detector systems; the field selector; and the real-time computer. Spares were procured and tested for all components and one Aladdin detector array from the Cryogenic high-resolution InfraRed Echelle Spectrograph (CRIRES), even if only partially compliant, has been kept as an emergency spare detector.

CRIRES is undergoing a major upgrade that includes a new gas cell and an etalon calibration system to achieve a radial velocity precision of 2–3 m s⁻¹, enabling it to search for planets of super-Earth masses in the habitable zones of M-dwarf stars, and a novel polarimetric unit that can be used to characterise stellar mag-

netic fields in low-mass objects. A cross-disperser increases the simultaneous wavelength coverage by a factor of about ten, and three new HAWAII 2RG detectors accommodate the new spectral format. This general refurbishment will prolong the life of the instrument.

All the components of the upgraded instrument, known as CRIRES+, were delivered to ESO Garching, where they were integrated in 2017. The warm part (including the Multi-Application Curvature Adaptive Optics (MACAO) unit) was fully rebuilt and new optical components with fresh coatings have been ordered. The instrument went through a total of three cooldowns; the first was to test the function and the behaviour of

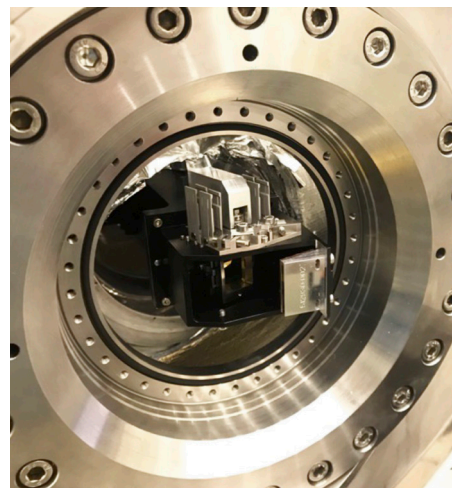

The CRIRES+ slit unit.

ESO/R. Dem

MATISSE Project Y. Bresson



MATISSE, at the Observatoire de la Côte d’Azur in France, is being transported to Chile to be integrated into the VLTI.

ESO/A. Glindemann



MATISSE arriving at the VLTI laboratory.

the cryogenic system, the second included the detectors, and the third produced the first cross-dispersed spectra in the *J–K*-bands. The CRIRES+ PAE slipped by about 6 months, and is now planned for Q3 2018. This will be followed by its shipment to the VLT, where it will replace VIMOS and be mounted on UT3.

Instruments in design and under construction

The Enhanced Resolution Imager and Spectrograph (ERIS) will be a new adaptive-optics supported infrared instrument for the *J–M*-bands (1–5 μm) at the UT4 Cassegrain focus. The adaptive-optics bonnette will feed both an infrared imager (NIX) and the upgraded SPectrometer for Infrared Faint Field (SPIFFI) of the SINFONI instrument. ERIS will use the AOF deformable mirror and one of its lasers to improve both the spatial resolution and sky coverage compared to the current NACO and SINFONI instruments. The Final Design Review (FDR) took place in May 2017 and was passed in October after a few critical issues were resolved. The project proposed adding two new modes: low-resolution spectroscopy with the NIX camera system and a coronagraphic mode. These were accepted for implementation. The procurement of the components is advancing and a readiness meeting was held in November to start the manufacturing, assembly, integration and testing (MAIT) phase for the NIX camera.

The Multi-Object Optical and Near-infrared Spectrograph (MOONS) is a 0.8 to 1.8 μm multi-object spectrometer designed to work at the Nasmyth focus of the VLT. The instrument will have 1000 fibres patrolling a total field 25 arcminutes in diameter. There will be two spectral resolving powers: $R \sim 4000$ spanning the full near-infrared wavelength range and a higher-resolution mode which gives $R \sim 9000$ in the *I*-band window and $R \sim 20\,000$ in a region of the *H*-band window. The lower-resolution mode is optimised for measuring galaxies with redshifts greater than one and the higher-resolution mode is optimised for stellar surveys.

MOONS has two main parts: the rotating front end, which is at the focal plane and

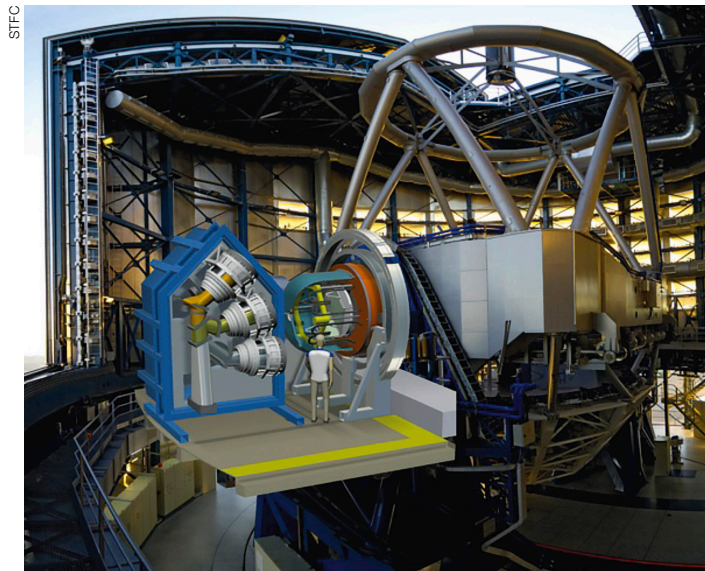

Left: Artist's impression of the MOONS instrument on the VLT.

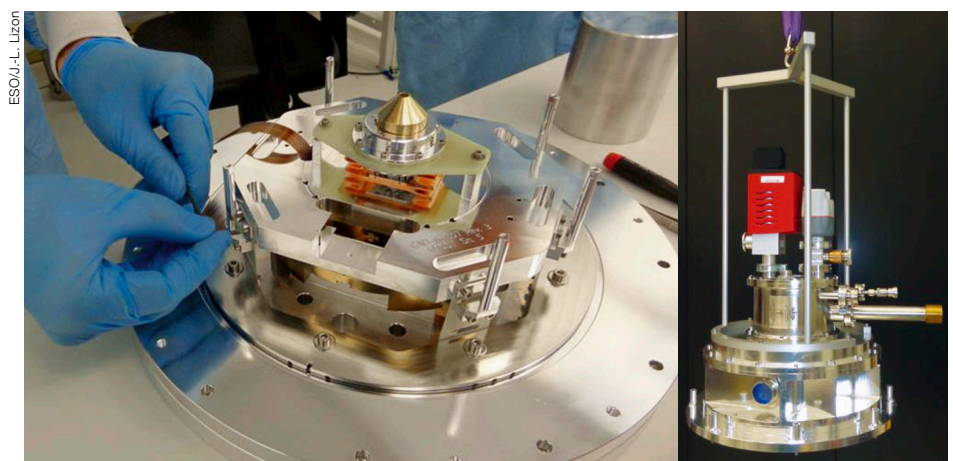

Below: Integration of the 4MOST detector (left) and the fully integrated 4MOST detector vessel (right).

houses the fibre positioners, acquisition system and the metrology system for the fibres; and the cryogenic spectrograph, which houses the spectrograph optics, volume-phase holographic gratings and detectors. The two parts are connected by fibres. The FDR of the whole instrument took place in March 2017 and the critical action items were closed a few months later. Orders have now been placed for all major items. The detector tender has also been finalised with the offer for the red-sensitive optical Charge Coupled Devices (CCDs).

4MOST will be a world-class facility for fibre-fed multi-object spectroscopy and will be installed on VISTA. Its unique capabilities result from the combination of a large field of view, medium and high spectral resolutions in the visible range

for both Galactic and extragalactic astrophysics and very high multiplex capabilities. An important milestone was achieved in 2017 when the consortium had obtained sufficient funding to guarantee the construction of the third (low-resolution) spectrograph, so the baseline for the instrument is the full complement, with 2400 fibres (1600 low resolution, 800 high resolution) available simultaneously. The FDR for the long-lead items took place to allow the procurement of major optical components which will require a long time for production and delivery. The detector vessels for the 10 large CCDs are being integrated — the first one is currently being tested and will be delivered soon. The FDR for the rest of the systems is planned in Q2 2018. The objective is to install 4MOST on the VISTA telescope in 2022.

Infrastructure projects

AOF

The AOF made fundamental steps towards completion in 2017. Almost one commissioning slot per month has resulted in the full qualification and validation of the GALACSI/MUSE wide-field mode and the GRAAL/HAWK-I ground layer adaptive optics mode. After its re-integration in the New Integration Hall in January, GALACSI was installed on the telescope in March and on-sky tests were started. The adaptive optics correction capability was confirmed on sky but most of the effort consisted of integrating the system in the UT4 telescope environment and ensuring robust operation.

Science Verification took place successfully in September and GTO time was granted using GALACSI and MUSE in the wide-field mode configuration in the autumn. In September, similar efforts were deployed on GRAAL; the positive results obtained with HAWK-I mean the system will soon be offered to the community. Data obtained during commissioning confirm the expectation that the amount of light injected into image pixels can be enhanced by a factor of two using GALACSI. GALACSI will correct for ground-layer turbulence in the MUSE 1-arcminute field of view, considerably improving the final image quality, especially during conditions when there is a high concentration of turbulence close to the ground (< 900 metres).

GRAAL also met specifications over its 7-arcminute field of view (using a different metric from that used for GALACSI). The robust implementation of the complete AOF including the 4LGSF and DSM with its adaptive optics modules and instrument is particularly impressive. It takes under 2 minutes to complete the acquisition sequence which includes the following steps: launching the laser beams; acquiring them; acquiring and centring the tip-tilt star; and then closing the high-order and low-order loops and managing all the annex servo loops and offloads. GALACSI narrow-field mode commissioning will start in early 2018 and will be the last activity for the AOF project. The narrow-field mode is the most challenging configuration of the AOF and the image correction targeted will feature a

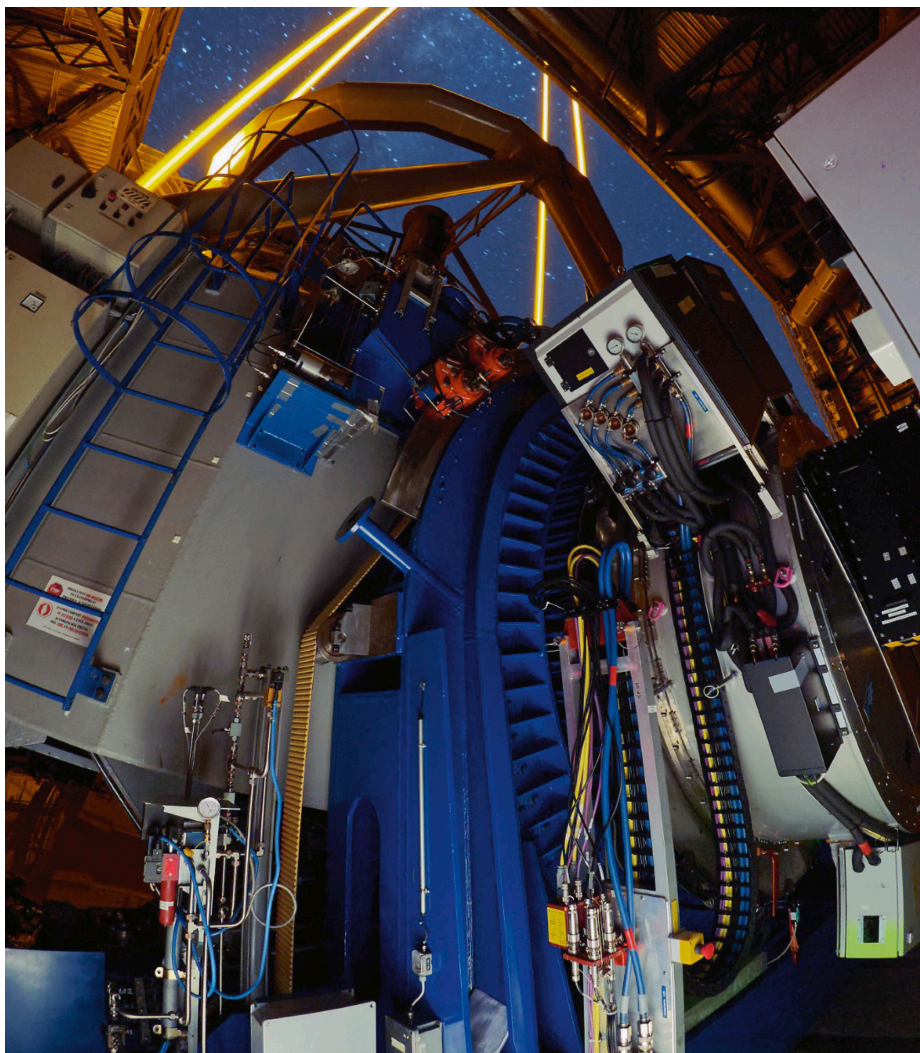

R. Bacon

Above: GALACSI on UT4 (Yepun), between the Nasmyth focus and MUSE.

Below: The planetary nebula NGC 6563 observed before (left) and after (right) the use of the AOF with MUSE, revealing faint structures that have never been seen before.



ESO/P. Weilbacher (AIP)

diffraction-limited core with Strehl Ratios as good as 10% (in the *R*-band).

VLTI facility

Begun in the summer of 2014, the VLTI Facility Project is two years from completion. Provisional Acceptance Chile has been granted for the service station of the ATs, the four star separators in the upgraded ATs, the four star separators in the upgraded coudé areas of the UTs (including its adaptive optics system MACAO), and the upgraded VLTI laboratory. These installations and upgrades have permitted the integration of the four CIAO systems, and the commissioning and release into operation of the spectroscopic mode of GRAVITY with both UTs and ATs. Quite a few activities were required to optimise the software interfaces to properly host GRAVITY and MATISSE, including modifications to the VLTI software, porting it to the VLT core documentation kit called VLT2016, the procurement of the feeding optics for MATISSE and its installation into the VLTI laboratory.

All the coudé mirrors of the ATs were replaced with a new set of optics and new coatings, which improved the VLTI transmission with the ATs at most wavelengths. Vibrations on the ATs have been mitigated as verified by the GRAVITY fringe tracker; only the impact of the wind remains to be resolved. The vibration mitigation campaign on the UTs was very successful. After the replacement of the cooling pumps, all UT baselines reached a record low level of vibrations, under 200 nm (root mean square). In the meantime, a vibration metrology system has been developed and its prototype tested at Paranal. When the final version is installed, measurement of vibrations will be carried out in daytime; they are currently limited to nighttime observations with GRAVITY. This monitoring is essential to maintain the low level of vibrations and to identify their cause.

The adaptive optics of the Auxiliary Telescopes, the New Adaptive Optics Module for Interferometry (NAOMI) underwent significant advances. The delta-FDR at the beginning of 2017 established the final design of the corrective optics, including its deformable mirrors. After that, the project progressed well, and the

first prototype system was fully integrated and tested in Garching. The first loop was closed in November 2017. The other four corrective optics are now in integration at IPAG (Grenoble) and will be delivered soon. A detailed integration and commissioning plan has been developed; it will require the closure of the ATs from September to November 2018. By the end of 2018, the VLTI will have better resilience against poor seeing, and a significant improvement in terms of fringe tracking performance and sensitivity.

Following the commissioning of NAOMI, the last activity of the VLTI Facility Project will be the development and deployment of "GRAVITY for MATISSE" in 2019; a fringe-tracking mode expected to significantly improve the sensitivity of the MATISSE instrument. The last pair of differential delay lines was also installed in Paranal in February 2017.

La Silla instruments

The LFC provides a series of equally spaced, stable spectral lines for an unprecedentedly precise wavelength calibration. After five years of development, the contract to provide a turnkey LFC system for HARPS was completed and the LFC was tested using daily calibrations over several months. After this period of testing, the last Fabry-Perot cavity became unstable, and needed repair. A part of the system's optical breadboard will be sent back to Europe. After reinstal-

lation, the LFC will be offered to the community; a maintenance contract has already been issued.

Two new spectrographs are under development for La Silla: one for the 3.6-metre telescope and one for the NTT. NIRPS will complement HARPS by providing 1 ms^{-1} precision spectroscopy over the *Y*, *J* and *H* infrared bands. NIRPS is on a fast track; it passed the FDR in 2017 and parts have been ordered and are in the process of being delivered to the consortium, which is led by the Université de Montréal and the Observatoire de Genève. The Memorandum of Understanding with ESO was signed in early 2017.

The second spectrograph for La Silla is SOXS which will provide instantaneous cross-dispersed échelle spectroscopy from 350 to 1750 nm at the NTT. It is geared towards the rapid follow-up of transient objects. In 2017, the instrument passed PDR; a novel design for the visual spectrograph was presented, which enhances the instrument transmission and which will be consolidated in 2018. A Memorandum of Understanding with INAF/Osservatorio di Brera for the design phase of SOXS was signed in early 2017. The FDR and a decision on the construction and implementation phase are expected in 2018.

Conceptual drawing of the NIRPS instrument that will be installed at the ESO 3.6-metre telescope. NIRPS is an infrared spectrograph designed to detect Earth-like rocky planets around the coolest stars.

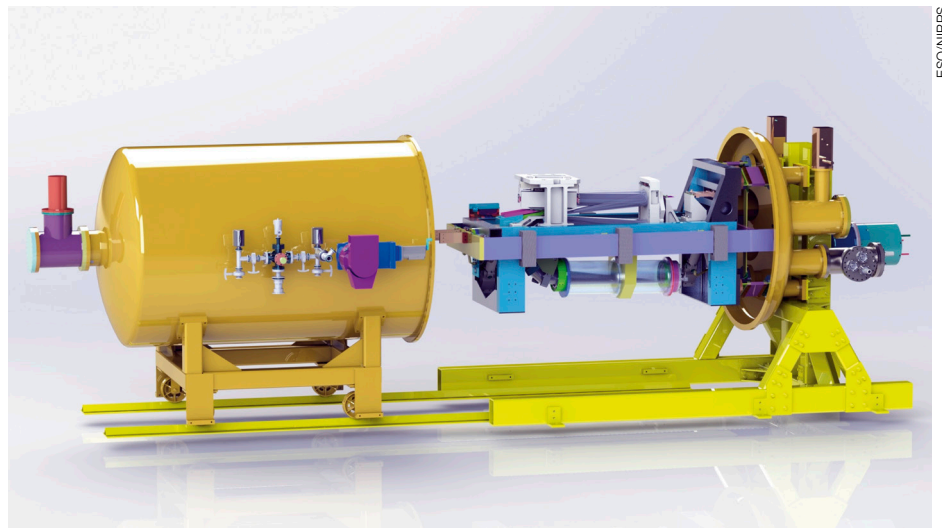

ESO/NIRPS



Technology Development

The ESO technology development programme is aimed at developing and securing the technologies that ESO will need to successfully conduct its scientific programme in the future. Although commercial industrial developments underpin many of the new projects, in some cases the technical risk and limited size of the potential market mean that industry is reluctant to take the lead. The development programme can therefore play a key role in initiating new technologies for ESO's instruments and telescopes. In addition to working closely with industry, ESO also collaborates with several European institutes to enable advances in key areas, for example laser guide stars.

The development of key adaptive optics components for the ELT made substantial progress in 2017. ESO initiated the procurement, from Teledyne e2v in the UK, of an 800×800 visible complementary metal oxide semiconductor (CMOS) sensor with associated Peltier cooling package, called the large visible sensor module (LVSM). With high readout speeds and low noise, these devices will be incorporated into compact cameras for wavefront sensing, which ESO will prototype and outsource to industry for production. Many elements of the cameras have been defined, including cooling, power supplies and main board and housing designs.

Artificial laser guide stars 90 km above the Earth, created by lasers tuned to the 589 nm line of sodium, act as reference sources for the measurement of turbulence-induced errors in the wavefront. A large amount of data on the achievable return flux from a laser guide star has been obtained since 2016, with initial results presented in June 2017. Preparations have also started on advanced adaptive optics techniques including uplink correction of the laser, pulsed lasers, dynamic refocusing and pyramid wavefront sensing of the laser guide star. This work is being carried out in collaboration with the University of Durham (UK), the Laboratoire d'études spatiales et d'instrumentation en astrophysique (LESIA, France), the Max Planck Institute for Extraterrestrial Physics (MPE, Germany), the Italian National Institute for Astrophysics (INAF, Italy) and the Instituto de Astrofísica de Canarias (IAC, Spain).

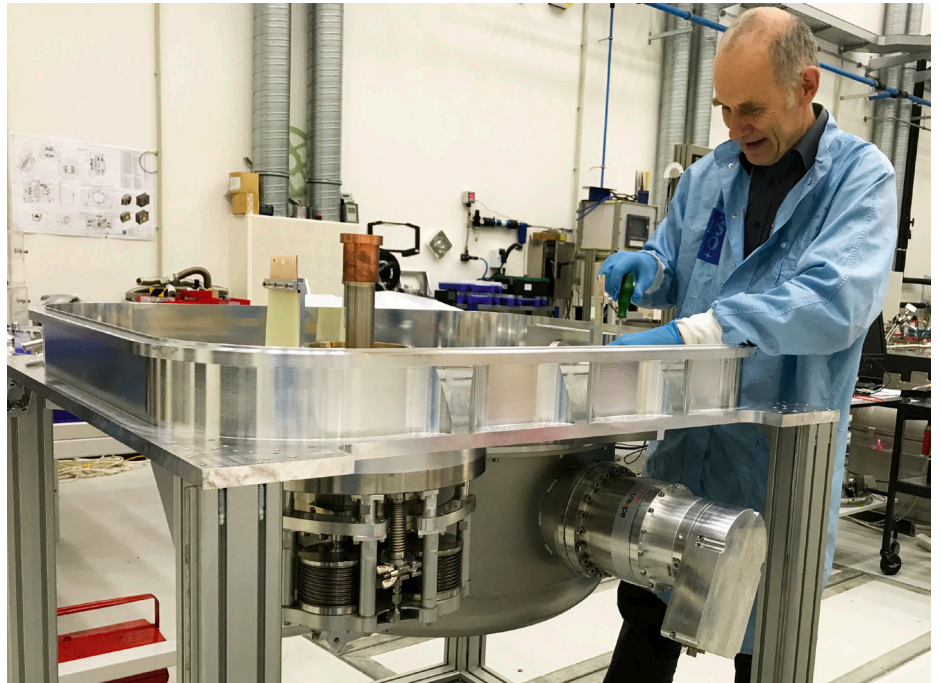

The ELT instruments will require large numbers of $4k \times 4k$ (or equivalent) infrared sensors for their focal planes. As in the VLT era, given our experienced detector team and well-equipped laboratories, ESO will be testing and delivering the sensors and the required controllers for the first generation of ELT instruments. To assist with this, we have developed

The FIAT test facility undergoing final assembly in the ESO integration hall.

a new test facility, known as the FIAT, which will be able to optically test two such devices at a time, in a fully automated way. With a very low background and an operating wavelength out to $5 \mu\text{m}$, FIAT will be able to make difficult but critical

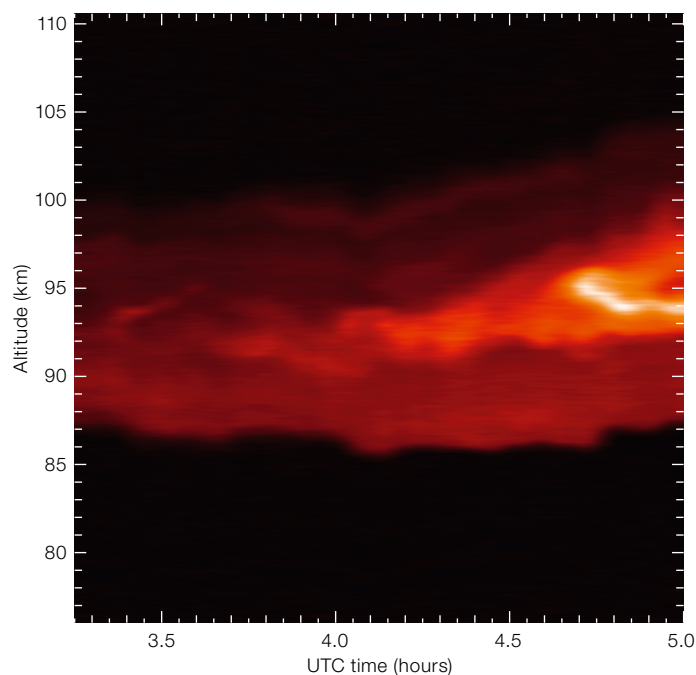

The evolution over time of the height and density of the sodium layer in the mesosphere. The bright feature on the right is likely due to ablation of a meteorite depositing fresh sodium in the upper atmosphere. This was obtained with the Isaac Newton Telescope sodium profiler and the ESO Wendelstein laser guide star in June 2017.

measurements in areas such as image persistence and dark current. In addition, a precision spot projection system will enable intra-pixel quantum efficiency measurements to be made.

The year has also seen excellent progress with other projects in the technology development programme:

- The NEAR project will modify the VLT Imager and Spectrometer for mid-InfraRed (VISIR) in order to greatly enhance its ability to search for potentially habitable planets around Alpha Centauri, the closest stellar system to the Earth. The FDR was completed successfully in August. NEAR is funded by the Breakthrough Initiatives, which were founded in 2015 by Yuri and Julia Milner.
- A first phase of development in collaboration with industry of new compact and high-order deformable mirrors has progressed well and will finish in 2018.
- A new project to develop low-noise cryogenic amplifiers for use on ALMA has started, with a successful call for tender for consortia/industry to develop these.
- A small in-house programme of research into high-contrast techniques has progressed well using the high-order test bench to test extreme adaptive optics performance. To date, more than 400 modes have been corrected.
- We have also made good progress with assembling a small consortium to develop larger (500 × 500) infrared avalanche photodiode arrays with Leonardo (UK).

A supermoon, rising behind the Cerro Armazones mountain, home of the ELT.





The Extremely Large Telescope

At the end of 2016, the ELT Programme Manager anticipated that 2017 would be “the primary mirror year”. A lot of steps were needed to launch the production of various primary mirror (M1) components such as segment blanks, segment polishing, segment supports, positioning actuators and edge sensors. Indeed, at the end of 2017, the only contract remaining to be signed was for the series production of the M1 segment supports. The call for tender process was concluded in 2017 and the contract was approved by the Finance Committee (FC) in February 2018. All other major M1 contracts had been initiated by the end of 2017.

The timely start of these contracts is particularly important for two reasons. Firstly, the production of the primary mirror lies on the “critical path”. This means that any delay can impact the date of first light. Secondly, these contracts have a certain degree of interdependence; for example, the blank is needed to start polishing, and the segment support is required at the end of the polishing process for final testing and corrective polishing by ion-beam figuring. Although the main focus in 2017 was on M1, impressive progress was also achieved in procuring other optomechanical units, for example, blanks, polishing and supports for the secondary and tertiary mirrors, M2 and M3, and

The President of Chile, Michelle Bachelet, attended the First Stone ceremony for the ELT. This photo shows ESO Director General Tim de Zeeuw (left), Roberto Tamai, Programme Manager for the ELT (second from right) and Andreas Kaufer, Director of the La Silla Paranal Observatory (right).

critical components such as the ELT technical facility building at Paranal, and the pre-focal station that hosts the sensors for telescope wavefront control. By the end of 2017 almost 90% of the material cost of ELT Phase 1 (amounting to about 800 million euros) had been committed and more than 20 major contracts (totalling over 500 million euros) are currently running.

In parallel with these procurement activities, effort was also dedicated to follow-up contracts. Some 2017 highlights include the following: the ELT dome passed its PDR in June; the M4 Unit passed its FDR in December; the final design and qualification contract for the M1 Segment Support concluded (enabling the procurement of the series); and the High Angular Resolution Monolithic Optical and Near-infrared Integral-field spectrograph (HARMONI) instrument had its FDR meeting in December. In addition, there was progress on hardware; for example, the first M4 mirror shell was polished down to its final thickness (less than 2 mm), the dummy M2 mirror was manufactured, and the blanks for M2, M3 and the first six M1 segments were cast and are in the process of ceramisation.

Internal activities progressed in 2017, such as the FDR of the M1 Local Control System in October and the initiation of a critical test bench called “Minuscule-ELT” (MELT) to develop and validate the telescope wavefront control algorithms.

December 2017 saw a set of important new resolutions from the ESO Council,

which authorised the procurement of previously unfunded Phase 2 items related to the primary mirror, i.e., the five inner rings of segments, a spare sector and a second M1 maintenance unit. This decision was strongly recommended by the external ELT Management Advisory Committee (EMAC) at its December 2016 meeting, and was made possible thanks to additional funds brought into the ESO budget by the strategic arrangement with Australia (see p. 102). With this major development, the ELT will have all the segments available to fill M1.

On the other side of the Atlantic, at Cerro Armazones in Chile, 2017 also yielded a number of significant milestones. The most prominent was the official First Stone ceremony held on 26 May in the presence of the President of Chile, Michelle Bachelet, and many other distinguished international and Chilean guests (p. 103). This ceremony marked the start of the ELT dome and telescope construction by the ACe consortium, and the site was formally handed over to the consortium at that time. Later in the year, further inauguration ceremonies marked the end of the 50-km extension of the Chilean electrical network by the Chilean electrical company Saesa, and in December, the connection of the Paranal Observatory to the public network. This marked the start of a new “green” era after 20 years of locally generated energy (using diesel and gas turbines) and paved the way for the electrical supply of the ELT.

The President of Chile, Michelle Bachelet, seals the time capsule at the First Stone ceremony for the ELT.





The ELT contract signature ceremony at ESO Headquarters. This picture shows representatives of all the teams involved: SCHOTT, the SENER Group, the FAMES consortium and ESO.

Science and Instrumentation

The scientific instruments currently part of the funded ELT programme are:

- HARMONI, an adaptive-optics-fed integral-field spectrograph for the optical and near infrared;
- MICADO (Multi-AO Imaging Camera for Deep Observations), a multi-conjugate adaptive optics (MCAO)-fed near-infrared imager with slit spectroscopy capability;
- MAORY (Multi-conjugate Adaptive Optics Relay), an MCAO module to feed MICADO and an auxiliary port;
- METIS (Mid-infrared ELT Imager and Spectrograph), an adaptive-optics-assisted imager/spectrometer for the thermal infrared;
- MOSAIC, an optical to near-infrared multi-object spectrograph (Phase A study);
- HIRES, an optical to near-infrared high-resolution spectrograph (Phase A study).

These instruments are being developed by consortia under agreements signed with ESO in mid-2015. Except for the last two instruments, these agreements include the complete development process from the preliminary design to installation on site.

2017 saw the first PDRs for the HARMONI instrument in November and for its Laser Tomography Adaptive Optics (LTAO) Module in December. The PDRs for sev-

eral other instruments (MICADO, MAORY and METIS) are scheduled for 2018 but good progress was made in 2017, with important intermediate milestones passed, such as system requirements reviews or interface definitions. The Phase A studies for both MOSAIC and HIRES also made good progress and will be completed in early 2018. The ESO ELT Instrumentation Project and the ELT Programme Scientist are following the development of the scientific instruments closely to ensure that the proposed scientific goals will be achieved.

Interest in the ELT and its instrumentation within the wider scientific community is very high and growing. The status of the ELT Programme was presented at several international meetings, including a five-day symposium entitled “Early Science with the ELTs”, which was proposed and has been selected for the IAU General Assembly in Vienna in August 2018.

Progress was also made in the critical development of wavefront sensors and science detectors that are to be delivered by ESO to instruments. This included Finance Committee approval for a development contract for natural guide star wavefront detectors. The science detector procurement remains a critical area from a cost and performance point of view.

Other activities have included the release of a new ESO standard for instrument cryogenic infrastructure to meet the ELT’s specific needs, progress towards a real-time computer “toolkit”, and adaptive optics wavefront sensing cameras

to be used by the instruments and the telescope.

New industrial contracts

No fewer than a dozen new contracts were signed and started during 2017. Four significant contracts were initiated at a ceremony in January. The first two contracts were signed with SCHOTT (Germany). They cover the casting and machining of the blanks for the ELT’s largest single mirrors — the 4.2-metre convex aspheric secondary and the 3.8-metre concave aspheric tertiary mirror — made from SCHOTT’s low-expansion ceramic material Zerodur®. The third contract was signed with the SENER group (Spain) for the design and manufacture of the sophisticated support cells for the ELT secondary and tertiary mirrors and the associated complex active optics systems. Those systems will ensure that the massive but flexible mirrors retain their precise shapes and are correctly positioned within the telescope in order to deliver optimum image quality.

The fourth contract was signed with FAMES, a consortium composed of Fogale (France) and Micro-Epsilon (Germany). The contract covers the design and fabrication of over 4500 edge sensor pairs for the 798 hexagonal segments of the ELT’s primary mirror. These sensors are the most accurate ever used in a telescope and can measure relative positions to an accuracy of a few nanometres. They form a fundamental part of the very complex system that will continuously sense the position of each ELT primary

mirror segment relative to its neighbour and allow the segments to work together to form a perfect imaging system. It is a real challenge not only to make sensors with the required precision, but also to produce them quickly enough for thousands to be delivered within the necessarily short timescales.

Later in the year, seven more contracts were approved, signed and initiated. In February, ESO awarded the contract to Safran Reosc (France) to polish the third mirror in the light path (M3). Safran Reosc will receive the blank from SCHOTT, design the mirror and its mounting interfaces, polish the surface and complete all necessary optical tests before delivery. M3 will be a 3.8-metre concave mirror, the same size as the primary mirrors of many current world-class telescopes.

At a joint signature ceremony at the end of May, two contracts were signed to produce the 798 segments for the ELT primary mirror (M1). The first one, for the casting and machining of the blanks, was signed with SCHOTT (Germany). The second one, for the polishing of the segments, was signed with Safran Reosc. As for the M3 mirror, the blank will be delivered by SCHOTT to Safran Reosc who will then design the mounting interfaces, figure and polish the segments, integrate them into their support systems and perform optical tests before delivery. During the polishing process, each segment will be polished until it has no surface irregularities larger than 10 nm. To meet the challenge of delivering such a large number of polished segments within seven years, Safran Reosc will build up to a peak production rate of one mirror segment per day. By the end of 2017, Safran Reosc had a detailed plan of the necessary refurbishment of a facility at its Poitiers plant, specialising in the production of high-tech optical and optronic (electro-optical) equipment. The contract for segment polishing is the third-largest contract that ESO has ever signed and the second-largest for the ELT (after the dome and telescope structure contract, which was awarded to ACe in May 2016).

Also in May 2017, ESO awarded a multi-million-euro contract to Teledyne e2v (UK) to design and produce a set of

LVSM modules for use on the ELT adaptive optics systems. Each sensor, with a size of 800 × 800 pixels, will employ Teledyne e2v's CMOS technology. Their extreme sensitivity and fast response will allow the ELT's adaptive optics systems to make tiny adjustments around 700 times a second to compensate for variations in Earth's atmosphere. This will ensure that the resulting astronomical images — of objects ranging from exoplanets to distant galaxies — will benefit from the highest resolution possible with a 39-metre telescope. The contract will last for four years and consists of two phases. In the initial phase, sample sensors will be designed and manufactured to demonstrate proof of concept. Following this a total of 28 sensors will be manufactured at Teledyne e2v's site in Chelmsford (UK); most of these will be installed in ELT instruments with the rest being deployed as needed.

In June, ESO signed a contract with the company Physik Instrumente GmbH & Co. KG (Germany), to construct position actuators that will adjust the positions of the 798 hexagonal segments of the primary mirror on the telescope structure. Each segment, about 1.4 metres across and weighing 250 kg, will be mounted via a support system on three positioning actuators — hence 2394 actuators in total. Based on the measurements from the edge sensors mentioned earlier, the control system of the ELT primary mirror will make tiny adjustments to the positioning actuators to maintain the mirror's overall shape, correcting for deformations which may be caused by changes in telescope elevation, temperature and wind forces, as well as limiting vibration effects.

The summer of 2017 also saw the signature of a contract with Cosylab (Sweden) for the development of the Core Integration Infrastructure (CII). This is a fundamental component of the telescope control software that will integrate all local control systems into the central control system and provide generic control system services such as messages, alarms and logging.

Finally, an agreement was signed in December with the company TOPTICA (Germany) for the supply of at least four

laser sources for the ELT adaptive optics laser guide star system. The lasers will be based on the design developed by TOPTICA for the 4LGSF on the VLT that has already brought a spectacular improvement in image sharpness.

Looking ahead to the next round of contracts, we can summarise the status of ongoing procurement as at the end of 2017. The following list of calls for tender were completed in the last quarter of 2017 (with the exception of the M1 Coating Plant, which was still ongoing); the associated contract awards are therefore ready for approval by Finance Committee in February 2018:

- construction all-risk insurance to cover the assembly integration and verification (AIV) activities on site from 2018 until the handover to operations in late 2024;
- ELT Technical Facility: a building to be constructed to house several assembly and future maintenance activities at Paranal;
- M1 segment support series production;
- prefocal station (PFS) for the Nasmyth focus A;
- M1 coating plant.

Running contracts

The number of running ELT contracts almost doubled in 2017, to more than 20 major industrial contracts worth over 500 million euros in total.

The oldest running contracts, placed in summer 2015 for the design and manufacture of the M4 adaptive optics mirror, are progressing well. The M4 unit passed its FDR in December 2017 after extensive design and prototyping activities by AdOptica (Italy) and the production of the M4 shells is underway. All Zerodur® blanks were procured by Safran Reosc (France), which has also completed polishing and thinning of the first shell to less than 2 mm. The other shells are being produced.

The largest ELT contract, with ACe (Italy) for the design, manufacture and erection of the dome and the telescope main structure, has progressed on two fronts. Firstly, in Europe, intensive design activities led to the PDR milestone for the

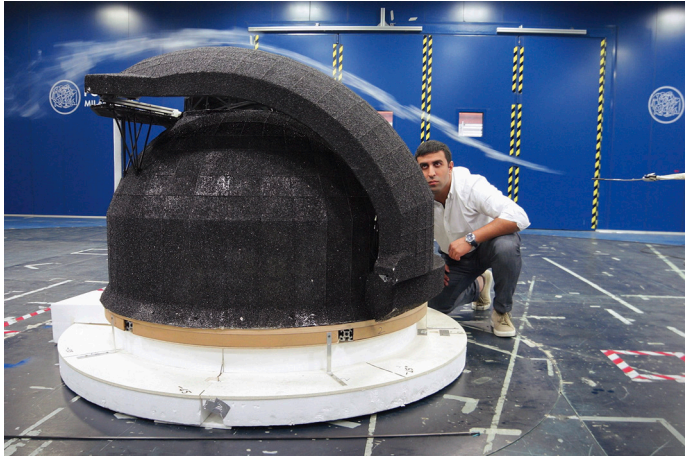

Preparing a 1:70 scale model of the ELT for wind tunnel tests.

dome in June, as well as progress with preparing for the PDR of the telescope structure, which is scheduled in February 2018. Secondly, following the formal hand over of the Armazones site from ESO to ACe in May, onsite activities began with the construction of the base camp, which will be able to accommodate up to 500 workers. ACe also delivered to ESO a mock-up of the M1 support structure that ESO will use to test the control system for up to seven M1 segments, including positioning actuators and edge sensors.

Throughout the year, ESO continued to use the expert services provided by Ramboll (Denmark), ISQ (Portugal) and Critical SW (Portugal) through ongoing consulting contracts. The contract with VDL (The Netherlands) for the final design and qualification of the M1 segment support, which started in 2015, passed the design validation review in April. This review included scrutiny of extensive test results obtained on an engineering model fully representative of the final units. The contract was completed by the end of 2017 with the production of six additional qualification models, including minor modifications stemming from the design validation review. Those milestones were critical to finalise the design and launch the call for tender for the series production, which will be reviewed by the ESO Finance Committee in February 2018.

The M2 polishing contract started in July 2016, when Safran Reosc passed the design reviews for the mirror inter-

face and the test setup, completed the qualification campaign for the pad adhesive and began the refurbishment of the former VLT M1 polishing building to accommodate the new machines for ELT M2 and M3 polishing. In addition, new machines were ordered and the 1.8-metre large aspheric matrix, to be used for the M2 stitching interferometric test, was produced.

Impressive milestones were also passed for new contracts signed in 2017. The M3 blank was cast at SCHOTT, ahead of schedule in May, closely followed by the casting of the M2 blank in August. Both blanks were annealed and are now in the slow cool-down (ceramisation) process, which lasts several months. The M2 and M3 cells contract launched in January went through the preliminary design

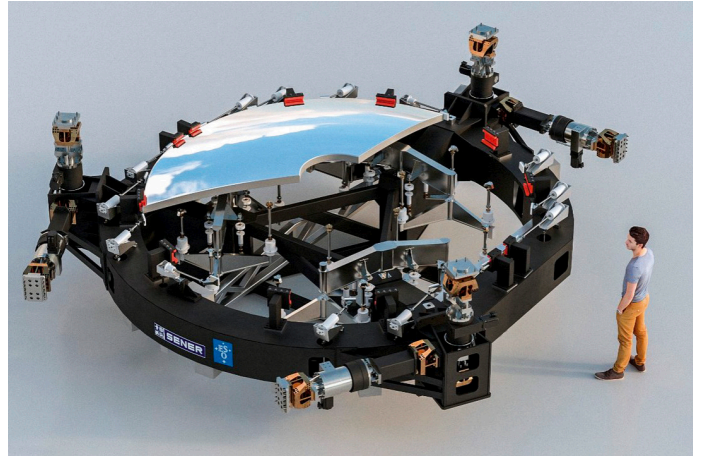

Preliminary design of the M2 cell developed by SENER.

phase with a review planned for January 2018. The edge sensor contract passed an interim design review in mid-2017 and a qualification test readiness review in the last quarter of 2017, in readiness for a PDR in the first half of 2018. The activities related to the M3 mirror-polishing contract follow a very similar workflow to those for the M2 polishing contract, which started a few months earlier. In particular, the design for the critical tools and processes to control and test the M3 optical surface was completed and the adhesive qualification was initiated.

The first hexagonal segments for the main mirror of ESO's ELT are successfully cast by the German company SCHOTT at their facility in Mainz.



SCHOTT/ESO

Other activities

Many internal activities occurred during 2017 to consolidate aspects of the system and the managerial structure of the programme. New assignments were made on the managerial side to adapt the team to reflect the latest developments, such as signing the new contracts reported above. Two staff members have been assigned to each contract; one focuses on the technical and managerial aspects while the second, a contract officer, is in charge of the commercial aspects. Overall, more than 20 ESO staff members are involved in these contract management activities, mostly on a part-time basis. The total ESO ELT staff effort in 2017 amounted to about 70 Full Time Equivalents.

A new role of Telescope Scientist was created alongside the current instrument scientists. Among the Telescope Scientist's tasks, an important activity was initiated to build the MELT wavefront control demonstration test bench. This test bench re-uses hardware that was developed in former laboratory experiment projects, such as a small piezo-driven segmented mirror, a turbulence generator and adaptive optics wavefront sensors, the objective being to simulate the most important characteristics of the ELT optical configuration and optical control loops. MELT will be an important component in the testing and performance verification processes for the ELT.

During 2017, further progress was made on planning the on-site AIV activities to ensure the smooth execution of this critical phase of the project, including organising a workshop at Paranal in October to identify and discuss ways in which to maximise synergies between both facilities with observatory staff.

Finally, a systems engineering effort was initiated in 2017 to define and prepare for an ELT System Verification Review in 2018. The review was initially recommended by the ELT Management Advisory Committee (EMAC) in December 2016 as an important step to further ensure the scientific success of the ELT.

Model of the ELT, the largest optical telescope in the world.

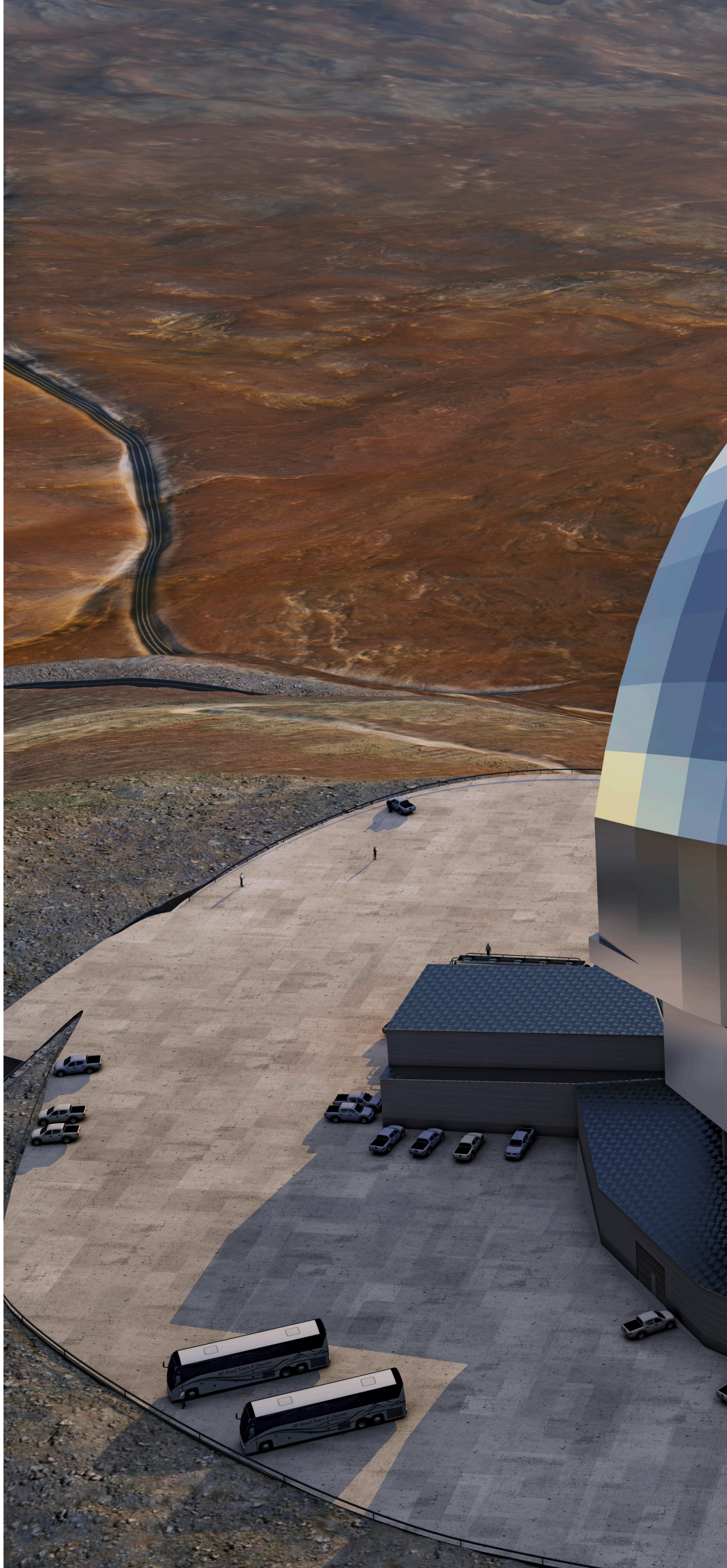

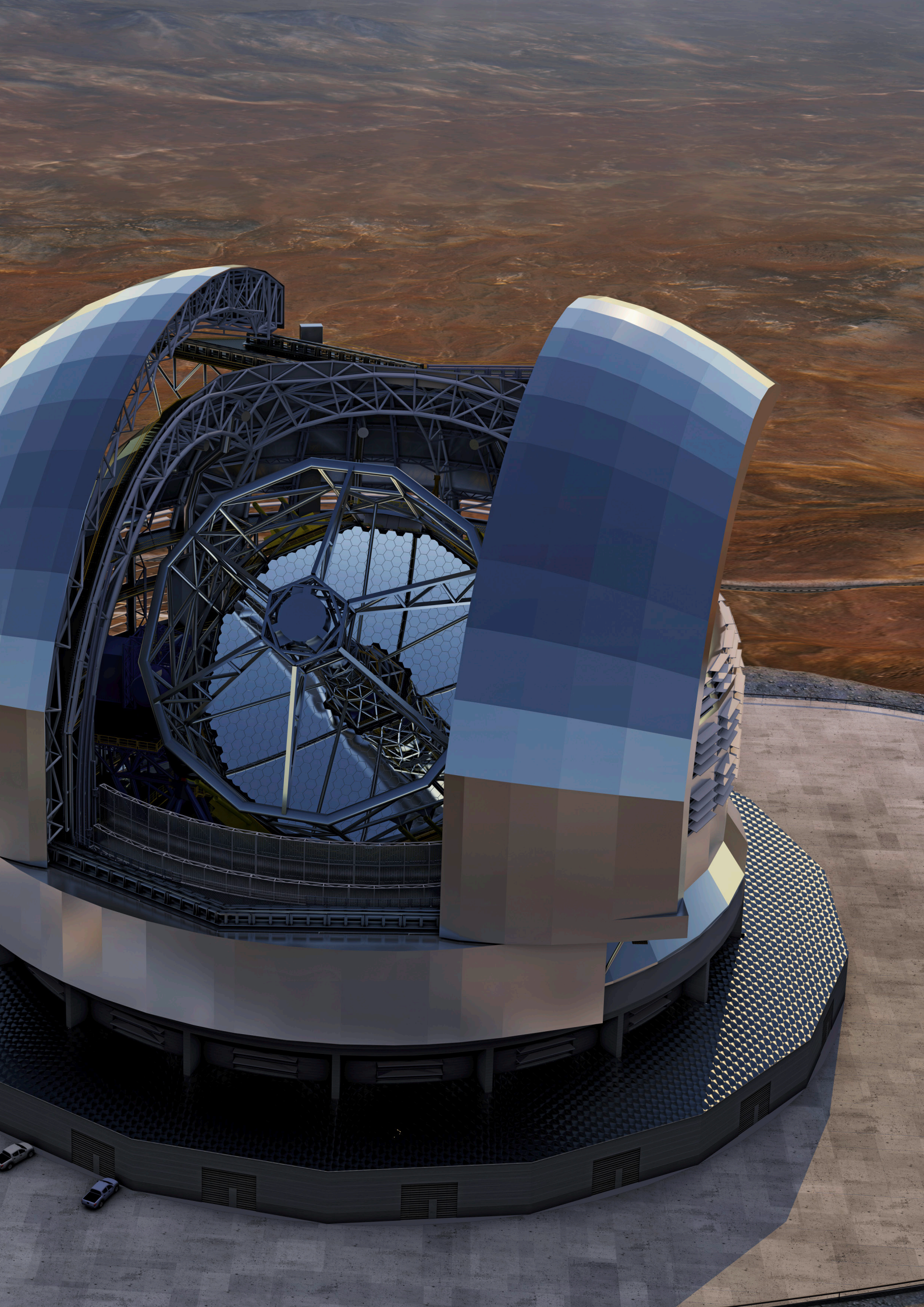

Engineering

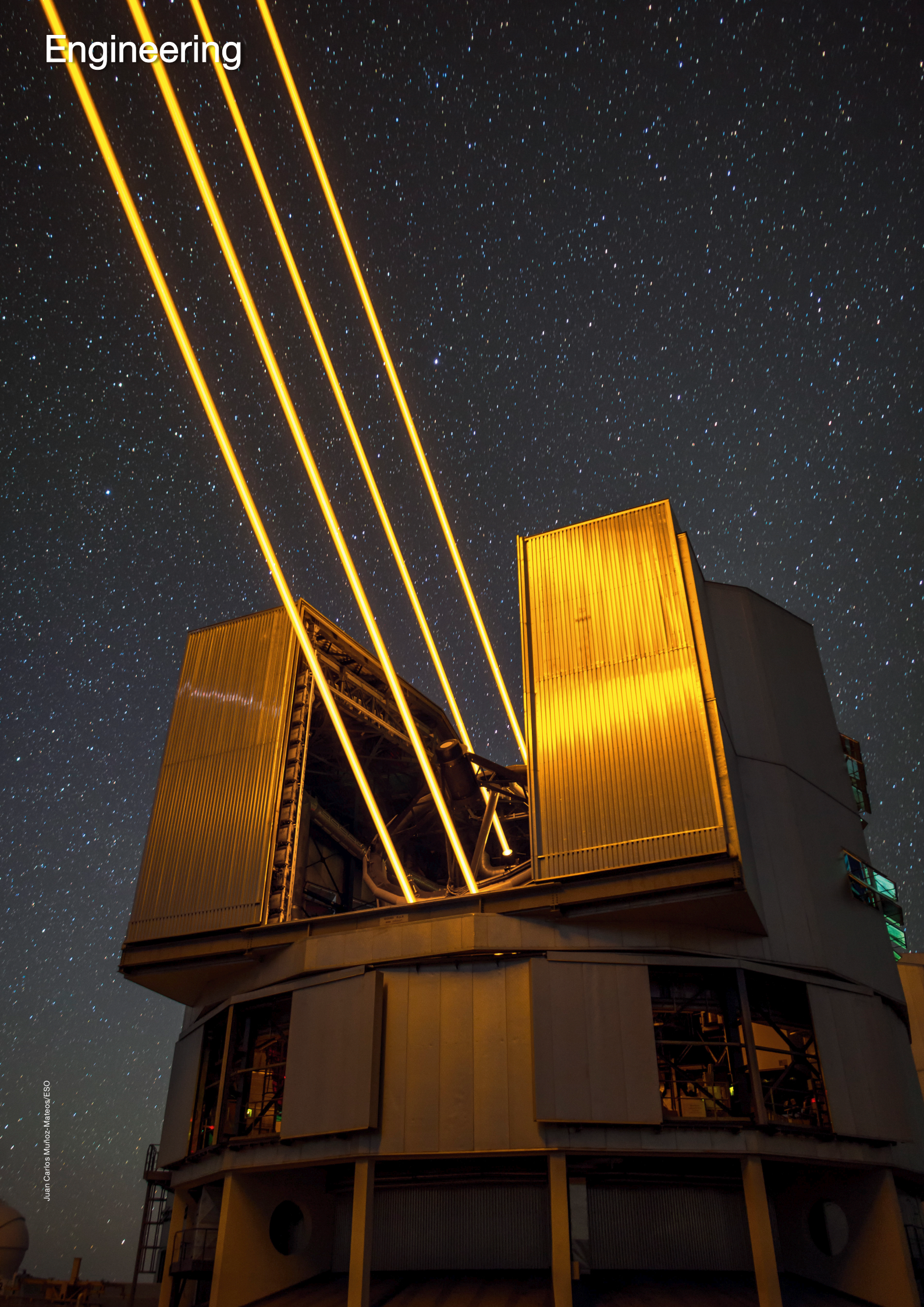

The Directorate of Engineering provides engineering resources and services to all ESO programmes and to the operations teams at the observatories and at ESO Headquarters. In addition, the Directorate of Engineering provides information technology (IT) services to the whole organisation.

In 2017, the Directorate contributed to the development and maintenance of instruments and infrastructure at the La Silla Paranal and ALMA Observatories. The Directorate spends a large fraction of its resources on the ELT programme and has been very active in following up industrial contracts as well as in related design, prototyping activities and feasibility studies for the ELT and its instruments.

Many of the activities carried out by the Directorate of Engineering are under the governance of the Directorate of Programmes or of Operations and are reported from different perspectives in the corresponding sections.

In addition, the Directorate is responsible for the development and maintenance of the engineering standards used by all projects. For example, the Directorate has invested effort into developing new cooling and cryogenic standards. The Directorate also maintains the laboratories, workshops and integration halls, as well as developing test facilities for detectors.

The 4 Laser Guide Star Facility (4LGSF) on UT4.

Mechanical Engineering Department

The department provides mechanical engineering support to almost all ESO projects, for example, the ELT, the Paranal Instrumentation Programme, ESO's assembly hall in Garching, the LPO and ALMA. The department operates the mechanical workshop and laboratory facilities in the technical building, manages the stock keeping of standard mechanical components and technical gases and provides maintenance and operational support to the detector test facilities. It operates several engineering tools, for example, finite element method (FEM) for structural analysis, mechanical computer aided design (CAD) systems, computational fluid dynamics (CFD) and product data management (PDM) for configuration control. The mechanical engineers and technicians are responsible for the definition, design, analysis, procurement and assembly of mechanical, opto-mechanical, cryogenic and vacuum systems for advanced telescopes and instruments. They are also involved with the installation and commissioning of previously designed systems on the telescopes and instruments in Chile and support on-site mechanical teams undertaking upgrade projects.

In 2017 the department made major contributions to: following up on projects

such as ELT subsystems, for example, the development of a seismic isolation damping system and verification of the hydrostatic bearing system; participating in reviews; performing cross-check analyses; and lifetime calculations of the VLT bogie bearings based on real data that can be applied to the similar calculations for future ELT dome rotation bearings.

Building Information Modelling technology — a process involving the generation and management of digital information that represents the physical and project-related characteristics of equipment and infrastructure — is being developed for implementation on ELT infrastructure. One example of a typical activity in the mechanical department was the development of a conceptual design and analysis of the PFS for the ELT. This led to a document on the technical requirements for tender documentation of the PFS.

The conceptual design for a new ELT M1 test stand was developed in the department and procurement documents were prepared and sent to the dome and main structure contractor. After manufacturing and acceptance, the test stand was installed in the Integration Hall in Garching. The position of the interface

The ELT M1 test bench in the technical building integration hall at ESO's Headquarters.

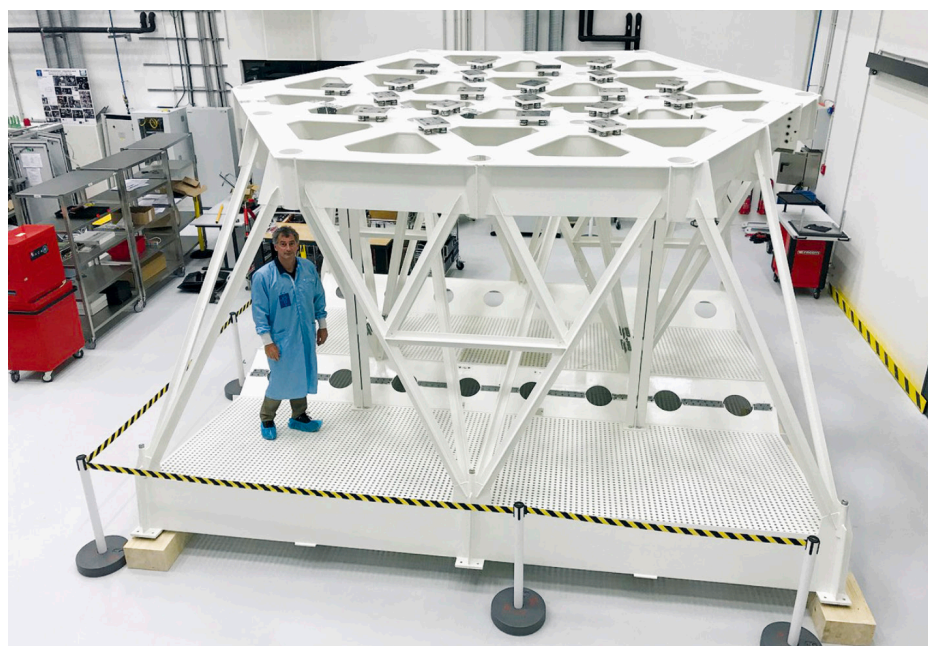

ESO/H. Bonnet

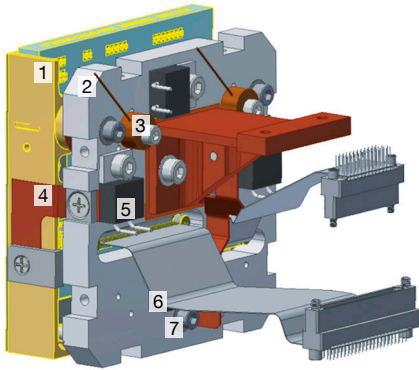

The Infrared detector (left) and the Infrared detector mount (right) for MOONS.

1. Hawaii 4RG infrared detector
2. Invar carrier
3. Heatsink Diode

flanges for the segment supports was verified with a laser tracker. Soon after, the first two segment fixed frames were installed and aligned on the test stand. Some tests were performed to optimise the alignment procedure, and afterwards one of the segment dummies was installed on the fixed frame to perform dynamic tests. Critical bolted connections in the M1 segment support structure have been internally verified.

The ESO internal document on the standards for “vacuum and cryogenics standard components” has been updated and released, and was very well received by both external consortia and ESO engineers. The document describes the vacuum/cryogenic design and the component standards for LPO as well as ELT instruments. The assortment of vacuum pump units available for all laboratories and projects was also replenished in the frame of testing new products to be selected as ESO standard.

Department members were deeply involved in many Paranal instrumentation and technology development projects, for example, GRAVITY, ESPRESSO, MOONS, NAOMI, CRIRES+, 4MOST, MATISSE, and the AOF, including the LGSF and DSM, GALACSI, ERIS, VLT infrastructure upgrade and the FIAT. Moreover, the design and analysis of the ELT Instruments HARMONI, METIS, MAORY and MICADO are being closely followed, and various ELT detector developments, for example ESO’s first design of a 4k x 4k

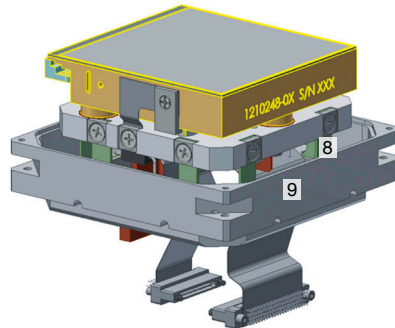

4. Flexible Thermal link between carrier and detector
5. 0.5 W Heater
6. Thermal cut-out
7. Detector mounting screws
8. Insulators
9. Spider interface plate

infrared detector for MOONS, are being supported.

Electronics Engineering Department

The Electronics Engineering Department is responsible for the definition, design and manufacturing of control electronic and detector systems and subsystems for telescopes and instruments, as well as for electrical compliance verification for all ESO projects. The domain of expertise in this department is large, covering instrument and telescope control electronics and automation, as well as detector systems design, production qualifications and tests.

Electronics engineering and workshop groups

The design work associated with the obsolescence management of VME-based (Versa Module Eurocard) systems is now almost complete. We have entered full production for the analogue I/O and MACCON DC and Stepper motion controllers and the digital I/O board prototype is due in the first quarter of 2018. When tested, it will be used to produce and support La Silla Paranal instrumentation for the next 10 years with all the main key VME boards.

At the instrumentation level, the upgrade of CRIRES+ was completed and ESPRESSO was being commissioned. At the telescope level, the VISTA telescope control system upgrade is being

finalised for installation at Paranal in the second half of 2018.

Regarding the ELT, the M1 warping harness system was developed and is now ready for full production by an external industrial company. This is a great success that has demonstrated the capability to develop and produce a complex system on demand and under pressure. The edge sensor project is now ready for PDR in the first quarter of 2018 and the M1 local control system (LCS) control system is also at an advanced stage.

On the ALMA side, the correlator fibre splicing has been implemented and the fibres replaced at the Array Operations Site (AOS). In addition, some reported issues related to the control electronics on the antennas were followed up.

At the infrastructure level, most of the detector laboratories have been upgraded and the clean room and associated laboratories have been completely refurbished. The infrared detector test bench is now in operation and the FIAT vessel arrived at the ESO premises for full integration by Q2 2017.

Compliance Engineering Group

Through the efforts of the Compliance Engineering Group, the LPO observatories are now connected to the Chilean grid. This is a major success and essential for the integration of the ELT at LPO. The Compliance Engineering Group has been involved in the telescope dome and main structure project, authoring and reviewing technical specifications for forthcoming ELT contracts, along with instrument documentation from the consortia. On the safety and compliance engineering side, a team has continued to work on ELT system hazard analysis (involving the identification and reporting of inter-system safety hazards and organisation of a hazard analysis evaluation team).

Detectors Group

On the VLT, the ESPRESSO and MATISSE instruments were being commissioned and the new CRIRES+ detectors are fully operational. The new infrared test facilities will be used to qualify all the ELT infrared detectors and are therefore a key part of the test infrastructure. Overall,

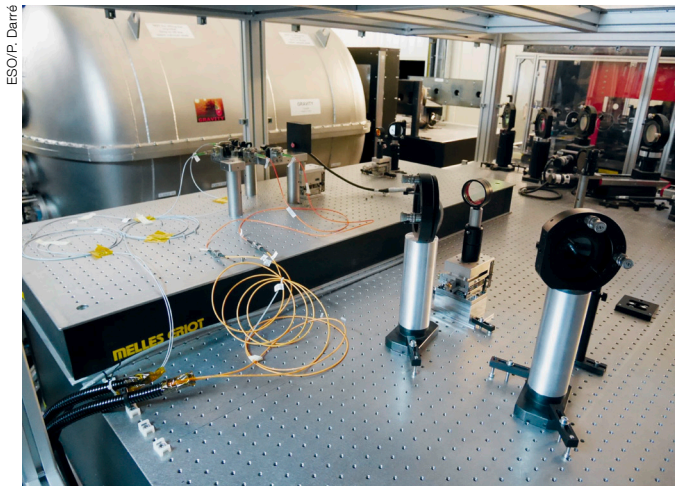

ESO/P. Darré

efforts have been concentrated on upgrading and rationalising the test infrastructure for detectors to be ready for the ELT. The NAOMI detector interfaces were also developed successfully and should enter production in 2018. After some problems with one of the detector providers, the contract to develop the new visible wavefront sensor detectors is back on track.

Above: The VIBMET experiment in the VLTI laboratory at Paranal.

Right: End-to-end simulation of a Single Conjugate Adaptive Optics (SCAO) mode. The numbers give the scale of the wave-front deformations.

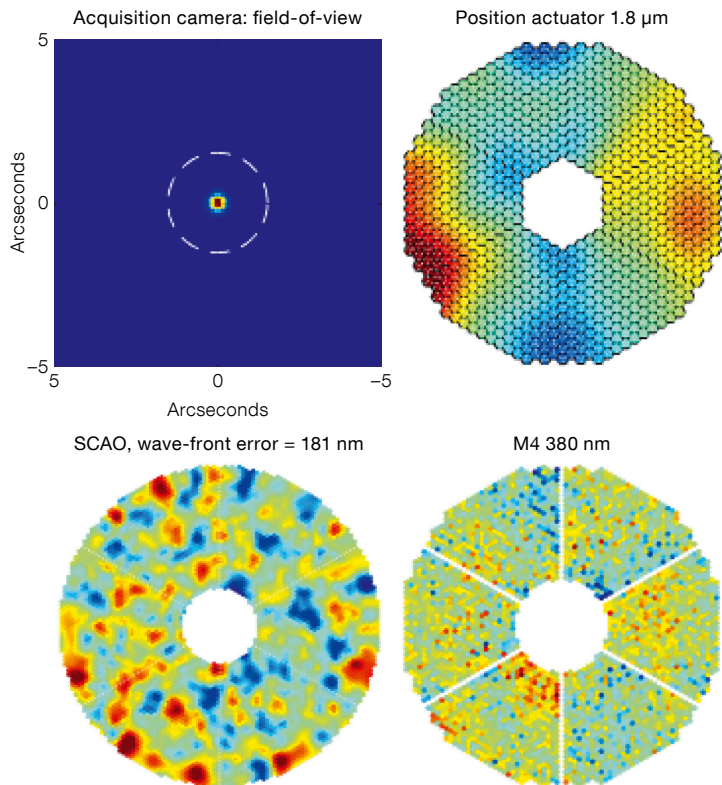

ESO/H. Bonnet

The team has continued its work on the HARMONI, MICADO and METIS ELT instruments and delivered PDR documentation for some of these.

Systems Engineering Department

The department consists of four groups. The Processes and Standards Group, and the System Analysis Group mostly support the ELT Programme. The Adaptive Optics Group and the Instrument Systems Group work together with the community to build and upgrade LPO and ELT instruments. The department provides all the functions of systems engineering, from technical coordination and design architecture to system analysis, including configuration and performance management.

Processes and Standards Group

The work done by the Processes and Standards Group in 2017 focused on ELT systems engineering. This essentially included the ongoing activities required to ensure that the ELT follows a coherent systems approach to meet the top-level requirements, in particular, as it concerns

the development of the many subsystems. These activities include: requirements and interfaces management (i.e., keeping the requirements database up to date and leading the preparation of the interface control documents); documentation and configuration management, with emphasis on the change control process (which consumes significant resources); keeping the technical budgets updated according to the evolution of the design; and verification management with the definition of a system verification. Finally the group made contributions to the instrument design reviews that took place during the year.

System Analysis Group

This group provides and maintains end-to-end models of wavefront control for the ELT and VLTI. It also provides project management and support to the common instruments systems research and development project and to the VLTI. The main milestones of 2017 were reached for the VIBMET (VIBrations METrology) and MELT projects.

VIBMET is a laser-metrology-based system implemented in the VLTI laboratory to

monitor the vibrations produced by the UTs. A prototype was tested in Paranal in September 2017. The final system will be installed in March 2018 on the four UTs.

In 2017, the ELT System Analysis group started preparing for telescope commissioning. A Matlab ray-tracing model was enhanced with a finite-element model of the adaptive mirror M4, and a model of the control system and its interfaces to the telescope. It will serve the MELT project, which is an upgrade of the mirror phasing experiment called Phasing the ELT with Adaptive optics Control Experiment (PEACE) and includes the deployment of the ELT Control System, which will be tested on a functional opto-mechanical model of the telescope. The group also provided the requirements for the opto-mechanical design of MELT.

Adaptive Optics System Group

The purpose of this group is to provide the ESO astronomical community with world-class adaptive optics observing capabilities that overcome the limitations arising from atmospheric turbulence. The group is involved in delivering adaptive optics modules for the second-generation

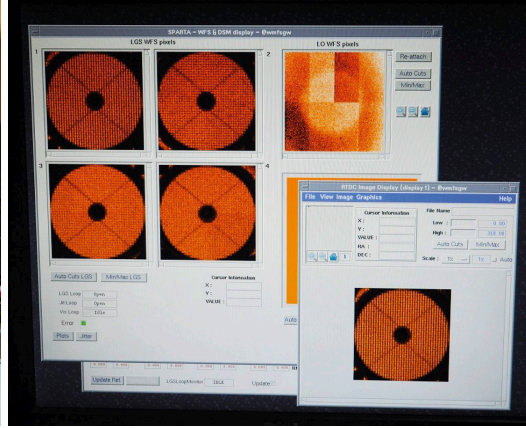

On the night of 22 to 23 March, the GALACSI team (left) celebrated the first light of the complex adaptive optics system with MUSE with its adaptive optics module, GALACSI. A screenshot of the panels showing the four wavefront sensors used to measure the turbulence and the shape of the secondary deformable mirror can be seen on the right.

VLT instruments, participating in the ELT programme, and developing the technology required by the next generation of adaptive optics systems. In 2017, the main highlights concern the AOF and Stereo-Scidar. The latter is an instrument used to measure the vertical profile of optical turbulence (C_n^2). It was developed by Durham University, delivered to Paranal in 2016 and has been used by the adaptive optics group to establish a database that will give access to long-term, high-resolution C_n^2 profiles for the first time.

GALACSI was re-assembled at Paranal, installed on Yepun (UT4) and commissioned on sky with MUSE. MUSE and GALACSI are now part of routine science operations at Paranal. On average, the image quality is improved by a factor of 2; the most frequent image quality delivered by GALACSI is an impressive 0.3 arcseconds.

Instrument Systems Group

Together with the project scientists, the group provides technical system and project management leadership for both internal and external instrumentation projects.

There are currently ten instrumentation projects — seven for the Paranal Observatory and three for the ELT — each of which is at a different phase. Examples include the ELT instrument HARMONI, which passed its PDR in 2017, the VLT mid-infrared instrument MATISSE, which started commissioning after a successful assembly and test phase at Paranal, and the VLT instrument CRIRES+, which should be shipped to Chile towards the end of 2018.

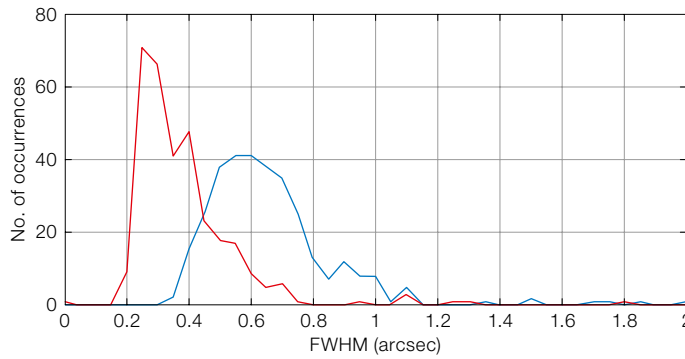

MUSE image quality (full width half maximum, FWHM) with (red) and without (blue) GALACSI, illustrating the performance of the adaptive optics.

The group’s activities also include the definition of standard documentation and processes for instrumentation projects, supporting the central role of instrument development as an ESO core objective and competence. As a result of these activities, the ELT programme is making increasing use of instrument systems engineering provided by the group, including both requirements engineering and the coordination of engineering disciplines.

Optical Engineering Department

This department supports ESO projects in the areas of optical design for telescopes and instruments, active optics and wavefront control, metrology for telescope alignment, laser guide stars, optical fibre technology and AIV of instruments. It also manages the optics laboratories and the integration facilities.

In 2017, some members of the department received awards in recognition of their achievements. Bernard Delabre was awarded the 2017 Tycho Brahe Prize

“in recognition of the development or exploitation of European instruments or major discoveries based largely on such instruments”. He retired in mid-2017 and was given ESO Emeritus status for his achievements throughout his 40-year career at ESO.

Domenico Bonaccini was elected a Fellow of the Optical Society (OSA) for fostering the development of photonics in novel astronomical instrumentation, including the field of laser guide star adaptive optics with the invention of narrow-band high-power Raman fibre amplifiers. In addition, the Guide Star Alliance, a collaboration involving Toptica Photonics, MPB Communications (MPBC) and ESO, received the 2017 Paul F. Forman Team Engineering Excellence Award from the OSA.

Beyond the strong engineering support to ESO’s programmes, the department continued research and development activities to assess new technologies and modern methods that may be beneficial to ESO projects. This included the use of a 24-channel fibre (“multi-line”) laser



Members of the ELT Assembly, Integration and Verification team.

interferometer to characterise the deformation of an ELT segment due to its warping harness, instead of relying on a large and expensive interferometric setup. Some field tests were also performed on La Palma in the area of tilt detection using laser guide star as well as laser guide star daytime detection.

A dedicated test bench was set up to investigate the feasibility of segmented mirror phasing with a laser guide star. The mirror phasing experiment PEACE was successfully restarted after resolving the obsolescence of key components, including its unique internal metrology. This allowed 61 hexagonal segments to be phased to nanometre precision. This bench is helping to develop know-how on phasing and coupling it with adaptive

optics; it will evolve into the MELT test bench by the end of 2018 as part of the ELT verification activities.

Significant effort was also invested in developing optical integration and measurement capabilities. This involved either the upgrade of existing equipment (interferometer, spectrophotometer, wavefront sensors) or the extension of the measurement portfolio using a laser tracker, laser multiline technologies and forthcoming computer-generated hologram testing. The department also started a “mirror reflectivity” measurement campaign on mirror samples exposed to the Paranal environment to support the ELT mirror washing specifications. The renovation of the 200 m² integration hall at the Headquarters was also completed.

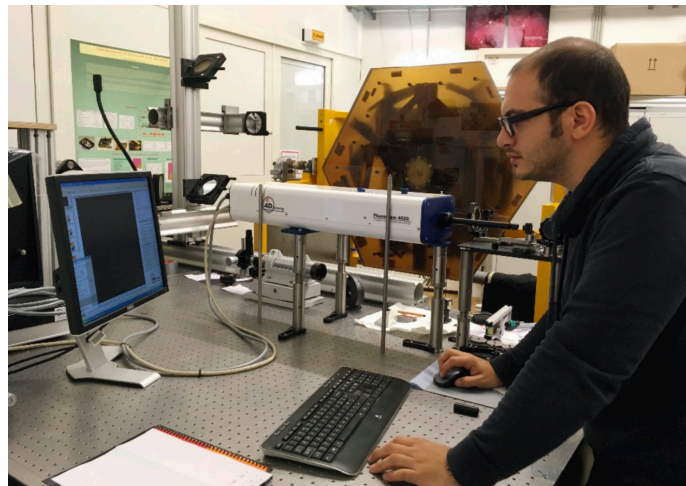

Optical measurement of an M1 prototype segment.

Other activities included establishing an “optics studio” software for standard optical design and tolerancing software. Site licences are now available for department staff. The department developed a Matlab code allowing the triggering of an optical ray-tracing and optical analysis of a telescope or instrument in the optics studio software tool. The objective is to enable the generation of optical sensitivity matrices from Matlab and using the optics studio as a ray tracer to check optical performance based on the mirror position and shape variation, as well as to help with the implementation of an alignment scheme.

Control Software and Engineering Department

As part of the project teams, members of the Control Software and Engineering department in the Directorate of Engineering are specifying, analysing, designing, implementing, verifying and maintaining control systems, and are responsible for the development of control software for (optical and radio) telescopes and astronomical instruments over the full software lifecycle.

Two specific projects are described here while all other activities are described in the corresponding Directorate of Programmes section.

ESA/INAF Osservatorio di Roma/SST/ESO

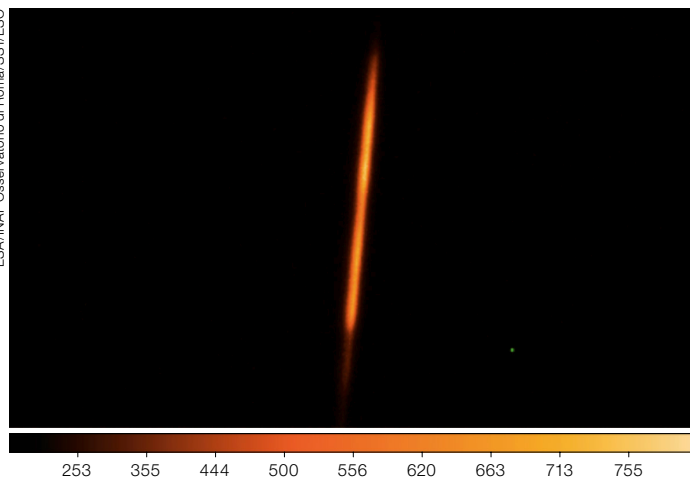

Daytime image of a laser guide star plume using the 1-metre Swedish Solar Telescope at La Palma. The LGS plume is created by the 589-metre laser beam crossing the mesospheric sodium layer. The apparent length from the Swedish Solar Telescope is 72 arcseconds, and a filter has been used to suppress the background light from the sky. The colour scale is in CCD ADU units.

The ELT Control Model

To test and integrate the ELT control system, it is necessary to create an environment that represents the ELT as closely as possible, with a reasonable amount of investment and effort. The ELT Control Model (ECM) was defined for this purpose. Some parts of the ELT control system are a 1:1 copy in the ECM, while others are scaled down versions or only simulations. In addition, the ECM also includes diagnostic equipment to support testing and verification.

The ECM infrastructure supports continuous integration and deployment, i.e., a fully automated infrastructure to bring new versions of the control software to the ECM and perform tests. The ECM also provides connections to various test stands or prototypes like the new M1 test stand. The ECM is now operational and can support the available prototypes, but it will, of course, require further extensions in future.

Deploying COTS Technical Cameras for VLT Instruments

NTCCD, ESO's long-existing Technical Cameras solution, has hardware components that become obsolete. There are also some other disadvantages such as space requirements and the price (~ 50 000 euros per unit). To address these, triggered by the ESPRESSO instrument, an ESO project was initiated in 2014 with the aim of investigating a replacement of the expensive NTCCD solution with off-the-shelf (COTS) solutions.

COTS devices are self-contained units that provide their own detector control hardware and software, and a high-level interface to the VLT software. This results in a major simplification of the instrument control system overall, compared to deploying the rather complex NTCCD system.

ESPRESSO uses nine such technical cameras and using the NTCCD would hardly be feasible. The instrument employs technical cameras for the purpose of field and pupil stabilisation and for the exposure meter. In collaboration with the ESPRESSO consortium, requirements were defined and some camera models were tested at ESO. Finally, the camera BigEye G-132B (Allied Vision

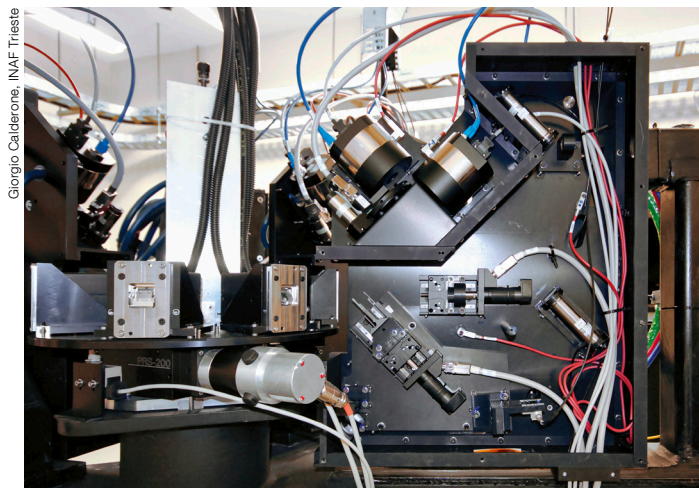

Giorgio Calderone, INAF Trieste

Detail of the ESPRESSO front-end receiving the beam from up to 4 UTs, some of the COTS Technical Cameras are visible.

Technologies) was selected. Owing to the requirement for liquid cooling, a special casing was necessary. The VLT software to control the COTS, Technical Detector Control Software (TDCS), allows consortia to use standard components provided by ESO and implement their own components (adapters) on top. The nine COTS technical cameras were successfully integrated into the ESPRESSO instrument structure and tested in Europe before shipping it to Paranal in autumn 2017.

Thanks to intensive testing in Europe, the deployment at Paranal went smoothly with just a number of minor issues found in the TDCS.

As a result of the positive experience with ESPRESSO, COTS technical cameras will be used for three other VLT instruments:

- ERIS will use a technical CCD from the same vendor as ESPRESSO, which should make the adaptation straightforward.
- 4MOST needs technical CCDs both for a refurbishment of the VISTA telescope control system and for the instrument itself. Because of demanding requirements, the project is considering high-end camera solutions.
- MOONS will deploy 33 technical CCD cameras of which one type is a CCD assembled in-house, based on COTS components.

The usage of COTS technical cameras brings many advantages including cost reduction, higher flexibility for instruments, less space occupation and less complexity in software. A drawback is that ESO

will have to deal with different camera models from different vendors. An initiative to standardise COTS technical cameras is ongoing, to mitigate this problem.

The benefits of deploying COTS technical cameras, however, outweigh this drawback massively. Based on this positive experience, a similar project has been initiated for the ELT instrument control software, to provide a software component for controlling COTS technical cameras.

Science Operation Software Department

The Science Operation Software Department provides resources as part of the ESO matrix for developing science operation software for the end-to-end operations of the LPO and ALMA as well as the ELT. The department is composed of three groups: Dataflow Infrastructure; Pipeline Systems; and Software Engineering.

In 2017, the department contributed to the organisation of the Astronomical Data Analysis Software and Systems conference, ADASS XXVII, which took place in Santiago de Chile in October 2017. This was the first time the conference had been held in Chile, and it attracted more than 400 participants, 130 of whom came from Chilean universities and institutes.

As part of the project teams, members of the Dataflow Infrastructure Group develop tools for proposal submission, observation preparation and execution, archive ingestion and retrieval, data

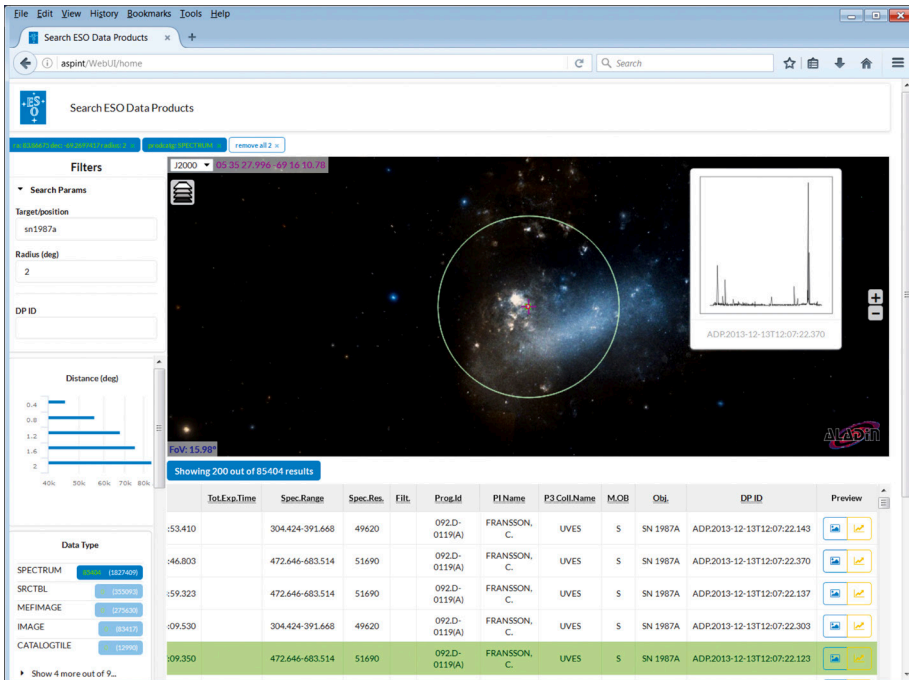

Screenshot of the new archive services web interface.

organisation and execution of pipelines. Highlights in 2017 included the release of the new Phase 2 tools to Paranal based on a web-based interface called p2. The Archive Services designed and developed a new web interface, a prototype of which has been demonstrated at several meetings. For ALMA, the main developments were related to the Alma Quality Assurance (AQUA) data quality system for observatory interfaces and to the monitor store and archive services. Moreover, the ALMA telescope calibration subsystem is now undergoing further development within the department.

The Pipeline Systems Group handles the scientific processing of data, the estimation of data quality with the exposure time calculators, the measurement of scientific data quality, and high-performance computing developments for ALMA/CASA. One of the highlights of 2017 was the commissioning of ESPRESSO, which required several interventions for the installation of the dataflow system, the commissioning and acceptance of the pipeline, and the update of the night log

Members of the HARMONI consortium and review team meet at ESO Headquarters for the preliminary design review of the instrument.

tool. The first PDR of an ELT instrument, HARMONI, took place in October.

The Software Engineering and Quality Group provides the tools necessary to support the development process, and the testing, integration, and release of scientific operation software. In 2017, work was done on the definition of the Software Quality Assurance Plan for the ELT, including participation in design reviews, and providing support to the VLT and ALMA dataflow developments. This mainly involved testing the VLT's new



ESO/P.Hendlek

Phase 2 tool p2, the VLT's GuideCAM and ALMA's AQUA and Observing Tool applications, as well as the collection of key performance indicators for ALMA releases. The development infrastructure was upgraded with the replacement of Apache subversion (SVN) servers and the update of the proprietary issue tracking system JIRA, which now also supports the ELT programme control office. Support was given to the transition of ALMA software development to a new version control system (called Git) and a different development process.

Information Technology Department

The ESO IT Department delivers services and supports users and science operations in fulfilling the ESO mission.

During 2017, IT supported the deployment of instruments at the observatory sites, the prevention of network obsolescence in Chile, and the completion of the initial firewall upgrade at ESO Headquarters. In addition, IT expanded server virtualisation to reduce the physical overhead, upgraded the email infrastructure and the web content management systems, and revised security.

IT also finalised a Frame Contract for Microsoft licenses, selected a supplier for the ESO and ALMA Science Archive nodes, and amended the IT service provider contract to provide improved on-site support.





The VLT, VST and ATs at the top of Cerro Paranal. VISTA can also be seen, in the distance, on the next mountain peak.

Administration



The Directorate of Administration comprises ESO's administration in Garching and in Chile. The functions include human resources, financial services, contracts and procurement, facility management, logistics and transport, safety coordination, the Enterprise Resource Planning (ERP) services and the operation of the ESO Guesthouse in Santiago. The construction of the ESO Supernova Planetarium & Visitor Centre is managed by the Directorate in cooperation with the education and Public Outreach Department. The Director of Administration is the Site Safety Responsible at Garching, Vitacura and the Santiago Guesthouse, and represents ESO at ALMA's Head of Administration meetings as well as in CERN Pension Fund matters. The Administration Office is in charge of the organisation of the Finance Committee meetings.

Following Patrick Geeraert's departure from ESO at the end of August, Claudia Burger, who was previously at the European X-ray free-electron laser (European XFEL) facility, took up office as the new Director of Administration in mid-October. The interim period was covered by Jean-Michel Bonneau as deputy.

Highlights in 2017 included a major upgrade of the ERP system with several improvements and new features, the signature of the second-biggest ELT contract for the polishing of the M1 mirror, and major progress in the construction of the Supernova, including some first visits with planetarium shows ahead of its inauguration in April 2018.

The ESO Supernova Planetarium & Visitor Centre at sunset.

Several major ELT contracts were signed in 2017, including the M1 Polishing contract with Reosc (France), the second-biggest ELT contract with a value in the range of 100 million euros. In total, 88% of the material budget of the ELT has now been contracted.

Together with Industrial Liaison Officers from the respective countries, the Contracts and Procurement Department organised Industry Days for Finland, France, Poland and Switzerland. The company representatives received information on ESO, its procurement process and its technologies, especially the ELT.

Council approved "Best Value for Money" as an additional adjudication principle for ESO contracts; implementation will take place over the course of 2018.

The ERP group completed a major upgrade, implementing a new version which went online in August 2017. This live rollout was successful and the feedback received from users was very positive. The most noticeable improvements are a friendlier user interface and access

via a web browser. Several further new features were also implemented, for example, the uploading of electronic invoices and the integration of the Visiting Astronomers database.

Safety provided advice to the ELT Dome PDR so as to detect potential safety-related shortcomings. The technical service corporation TÜV (Germany) carried out a number of safety tours focusing on laboratories and the assembly hall, and made recommendations.

In 2017, the façade works for the ESO Supernova Planetarium & Visitor Centre were finished and its interior was completed. The installation work for the exhibition started and all planetarium systems were tested. First visits, including a planetarium show, took place for science journalists and school classes.

At the Santiago office, the cafeteria in the main building re-opened in August after being expanded and refurbished to accommodate the growing number of staff.

ESO/F. Reckmann



Cleaning the façade of the ESO Supernova Planetarium & Visitor Centre.



Tim de Zeeuw and Patrick Geeraert at the opening cocktail reception of the newly extended cafeteria during their final visit to the Vitacura offices as Director General and Director of Administration.

Finance and Budget

Financial Statements 2017

Accounting Statements 2017 (in €1000)

Statement of Financial Position	31.12.2017	31.12.2016
Assets		
Cash and cash equivalents	96 949	79 268
Inventories, receivables, advances and other current assets	125 385	81 934
Non-current assets	1 110 911	1 106 920
Total Assets	1 333 245	1 268 122
Liabilities		
Short-term borrowing	0	0
Payables, advances received and other current liabilities	163 814	123 511
Non-current liabilities	546 843	567 611
Total Liabilities	710 657	691 122
Accumulated surpluses/deficits	577 000	569 610
Pension fund loss/gain	44 342	- 11 147
Other changes in net assets	979	22 570
Net surplus/deficit for the year	267	- 4 033
Total Net Assets	622 588	577 000
Total Liabilities and Net Assets	1 333 245	1 268 122

Cash Flow Statement	2017	2016
Cash Flow		
Net receipts	221 302	214 821
Net payments	-203 621	-190 606
Net Cash Flow from Operating Activities	17 681	24 215
Net Cash Flow from Financing Activities	0	0
Net Cash Flow =	17 681	24 215
Net Increase/Decrease in Cash and Cash Equivalents		

Statement of Financial Performance	2017	2016
Operating Revenue		
Contributions from Member States	164 959	158 533
Contributions to special projects	17 616	17 668
In-kind contributions	8 464	6 277
Sales and service charges	1 961	1 778
Other revenue	2 176	2 008
Total Operating Revenue	195 176	186 264
Operating Expenses		
Installations and equipment	2 515	2 939
Supplies and services	44 574	43 149
Personnel expenses	76 678	75 176
Depreciation of fixed assets	67 685	66 120
Other operating expenses	4 626	4 249
Total Operating Expenses	196 078	191 633
Net Surplus/Deficit from Operating Activities	- 902	- 5 369
Financial revenue	3 077	3 776
Financial expenses	1 974	2 534
Net Surplus/Deficit from Financial Activities	1 103	1 242
Non-periodic and extraordinary revenue	70	94
Non-periodic and extraordinary expenses	4	0
Net Surplus/Deficit from Non-periodic and Extraordinary Activities	66	94
Net Surplus/Deficit for the Period	267	- 4 033

Budgetary Reports 2017
(in €1000)

Income Budget	Actual	Budget
Contributions from Member States	208 047	194 388
Income from partnerships	1 973	1 970
Income from third parties	9 755	3 782
Other income	2 488	1 243
Consolidated entities	2 254	612
Total Income Budget	224 517	201 995
Expenditure Budget		
Programme	95 365	133 223
Technical infrastructure and production	6 945	8 825
Operations	72 869	75 585
Science support	9 163	10 068
General activities	25 265	27 195
Cherenkov Telescope Array	374	0
Financing cost	24	39
Consolidated entities	1 707	686
Total Expenditure Budget	211 712	255 621

Budget for 2018
(in €1000)

Income Budget	2018 (Approved)
Contributions from Member States	196 143
Income from partnerships	10 395
Income from third parties	2 951
Other income	3 122
Consolidated entities	2 379
Total Income Budget	214 990
Expenditure Budget	2018 (Approved)
Programme	172 917
Technical infrastructure and production	8 990
Operations	73 398
Science support	10 626
General activities	28 670
Cherenkov Telescope Array	44
Financing cost	510
Consolidated entities	1 697
Total Expenditure Budget	296 852

The External Auditors from the National Audit Office of Finland* have expressed their opinion that the financial statements for 2017 give a true and fair view of the affairs of the Organisation.

The accounting statements for 2017 show a surplus of 0.3 million euros compared to a deficit of 4.0 million euros in 2016. Operating activities ended with a deficit of 0.9 million euros which was more than compensated for by a net surplus from financial activities, mainly income from bank interest and positive exchange rate impacts, and a small net surplus from non-periodic and extraordinary income.

The net assets of the Organisation have increased by 45.6 million euros to 622.6 million euros at 31 December 2017, mainly caused by the positive impact of the revaluation of the Organisation's pension liabilities, which are held in Swiss francs.

Increased receipts from the Member States related to the ELT contributions and only a moderate increase in payments provided a positive cash flow in 2017 of 17.7 million euros. The cash position at 31 December 2017 stood at 96.9 million euros.

ESO Council approved the budget for 2018 in December 2017. The approved 2018 expenditure budget amounts to 296.9 million euros, reflecting a considerable increase compared to 2017. This is almost entirely driven by the increasing expenditure for the ELT Phase 1. In December 2017, ESO Council also approved the full M1 mirror for the ELT, which had previously formed part of the ELT Phase 2. The associated expenditure will start in 2019.

The approved income budget for 2018 amounts to 215.0 million euros. This comprises the regular contributions from the ESO Member States and includes their additional contributions for the ELT, income from third parties and partners and other income.

In 2017 ESO entered into a strategic partnership with Australia. The associated contributions, as well as some remaining funding from the Klaus Tschira Stiftung for the ESO Supernova Planetarium & Visitor Centre, are included in the 2018 income budget.

* Jari Sanaskoski (Director for Financial Audit),
Pontus Londen (Principal Financial Auditor),
Pauliina Mikkola (Senior Auditor, Financial Audit).





The La Silla Observatory.

The Human Resources (HR) Department manages all services connected to employment at ESO, from the definition of applicable policies to the execution and conclusion of employment contracts. Within this remit, and in compliance with ESO's Staff Rules and Regulations, HR manages the following tasks:

- planning and definition of policies and strategies for personnel resources;
- coordination of recruitment and selection to ensure diverse and talented staff;
- payroll and general compensation according to benefits and entitlements;
- supporting employees with regard to the implementation of the applicable rules, regulations and contractual terms;
- training and professional development;
- maintenance and storage of personnel records;
- occupational health and welfare;
- social security matters;
- family matters connected with employment contracts, including day-care and education provision at the European School Munich.

Recruitment, selection and reassignment

During 2017, HR published 49 vacancy notices, prompting a total of 1219 applications. The number of completed recruitments according to contract type were:

Contract type	No. of campaigns	No. of applications
International Staff Members	33	619
Local Staff Members	10	429
Fellows	13	213

All positions were advertised on the ESO Recruitment Portal. For International Staff Member positions, notifications were sent to all members of Council, the Finance Committee and the delegates of other ESO committees, as well as to national and international research centres and observatories. In addition, prominent advertisements for selected positions were placed in appropriate specialist publications and on recruitment web pages. All ESO advertisements contain a statement regarding the Organisation's commitment to equal opportunities.

The Foundation for Science and Technology of the Portuguese Ministry of Education and Science advocated for on-the-job training opportunities within the Directorate of Engineering and Directorate for Science. Two training opportunities associated with this were agreed upon in 2017.

Staff departures

The departures of staff in 2017 fall into the following categories:

Reasons	International Staff Member	Local Staff Member
Resignation	1	3
Expiry of contract	7	–
Retirement	3	2
Disability or mutual agreement	1	–
Total	12	5

Employee relations and communications

In 2017, three staff members celebrated 25 years of service and one celebrated 35 years of service.

After elections in September, the new International Staff Association (see p. 118) began regular meetings with the ESO management to discuss improvements regarding specific diversity and family-friendly policies.

Followed by the signature of the collective contracts for Local Staff Members, running from December 2016 to December 2019, different working groups developed on new articles regarding the following topics: transportation to and from pick-up points; the quality and type of working clothes; the impact of night shifts on health; Day and Night Operations support shift coordinators; emergency transportation; accident insurance coverage; and redrafting of the Spanish text.

Review of regulations for Local Staff Members in Chile

A working group led by the Director of Administration, with representatives from Local Staff Members and the unions at

Paranal and La Silla (see p. 119), continued the review of regulations for the Local Staff Members in Chile in light of developments in Chilean labour law. The conclusion of the review is expected in 2018.

Performance Management and Professional Development plan

Selected staff members tested an electronic tool for Performance Management and Professional Development between 2015 and 2016. Further evaluation in 2017 indicated that additional development would be needed before it can be implemented.

Learning and professional development

HR continued to deliver a wide range of development activities according to the Training Catalogue and the Fellow Development Programme.

The trend continues towards individualised trainings with shorter modules of half days, which offers more flexibility to the staff but does not replace more intense programmes. Additionally, HR offered drop-in talks and awareness sessions open to all staff. A special focus was on the "Alcohol and Drugs Misuse" and the "Fair Treatment, Courtesy and Respect" policies.

2017 Learning and Development activities:

	No. of staff members participating	Equivalent to (hours)
ESO Chile	135	1409
ESO Garching	236	1735

Health and welfare and social security

The annual CERN Pension Fund Information Meeting took place at ESO Headquarters in October.

The yearly review with the health care provider Cigna took place in October, resulting in minor amendments to the scheme. The individual insurance premium remains unchanged.

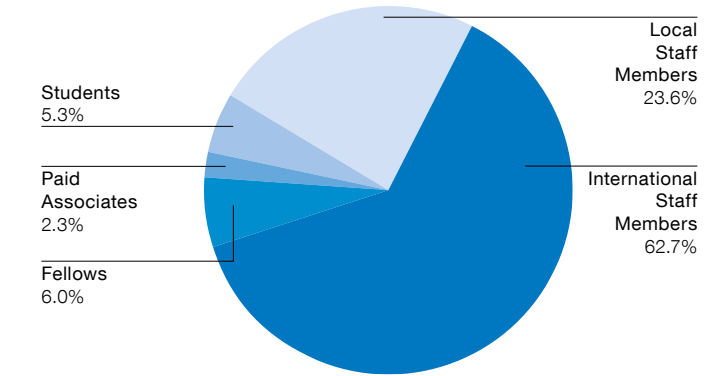
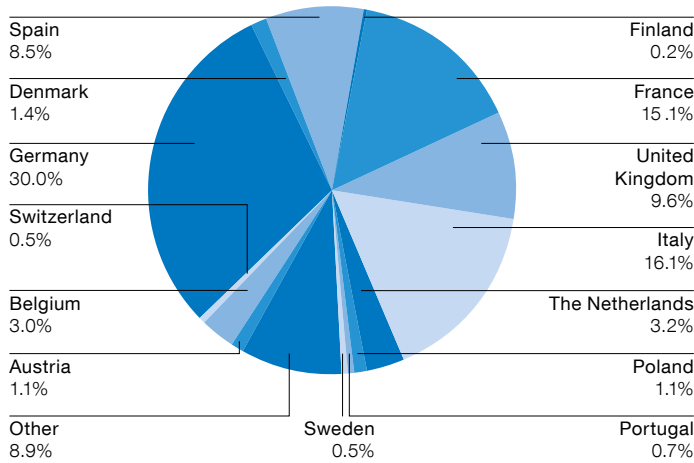

Left: Distribution of International Staff Members by Nationality.

Above: ESO personnel by category. In 2017, 695 members of staff were employed at ESO, including 436 International Staff and 164 Local Staff Members.

Collaboration and representation of HR

As an observer in the Gender Equality Network in the European Research Area (GENERA) Project, HR participated in the fourth “Gender in Physics Day” on 27 January 2017. The organisers presented comparisons of demographics, policies and initiatives from five EIROforum organisations (ESO, ESA, the European Synchrotron Radiation Facility [ESRF], European XFEL and the European Organization for Nuclear Research [CERN]), all of which share similar challenges. In the discussion panel, the HR managers agreed that “Gender equality in physics needs to become an everyday concern”, and that “more actions to promote Science, Technology, Engineering, Mathematics (STEM) careers to young female students are vital”.

As an active partner in the Munich Dual Career Office, ESO HR benefits from broad networking capabilities. The aim is to support the spouses of ESO international employees in their search for jobs in the Munich area.

HR was invited by the Federal Department of Foreign Affairs in Switzerland to represent ESO at the International Career Day in Bern, with the aim of attracting new staff members. It was attended by 54 international organisations and approximately 2000 visitors. As the only event in Switzerland exclusively devoted to international organisations, it provides an opportunity for motivated graduates to meet with recruitment specialists from these organisations.

HR represented ESO at the Administrative Board Meeting of the European School Munich (ESM) in September. 92 pupils were registered for the academic year 2017/2018.

Since May, ESO has had a contract with an agency to help staff in Garching to find suitable childcare solutions such as day nurseries or babysitters.

HR continued to participate in regular meetings of the HR Advisory Group of the JAO in order to discuss and resolve personnel issues of common interest.

HR participated in ESO’s Diversity and Inclusion Committee whose mission it is to advance diversity and inclusion at all levels in ESO (p. 120).

Girls’ Day at ESO Headquarters

On 27 April, ESO took part in the 17th Girls’ Day. Since 2001, a total of 1.5 million girls have participated in the German nationwide event at which enterprises, universities and research organisations offer approximately 10 000 events aimed at female students aged between 14 and 17. These open events help girls to make well-informed decisions about their future and encourage them to choose careers in science and technology. The Girls’ Day event at ESO Headquarters in Garching was fully booked, with 48 participants, and included two workshops, one about astronomy and one about engineering. There were 5–6 stations with different activities, some of which were hands-on and others had a more theoretical approach.



On 21 April 2017, ESO was among over 50 international organisations that presented their work and career opportunities at the International Career Day in Bern.





The Orion Nebula and associated cluster of young stars captured by OmegaCAM on the VLT Survey Telescope.

Organigram

Organisational Structure December 2017

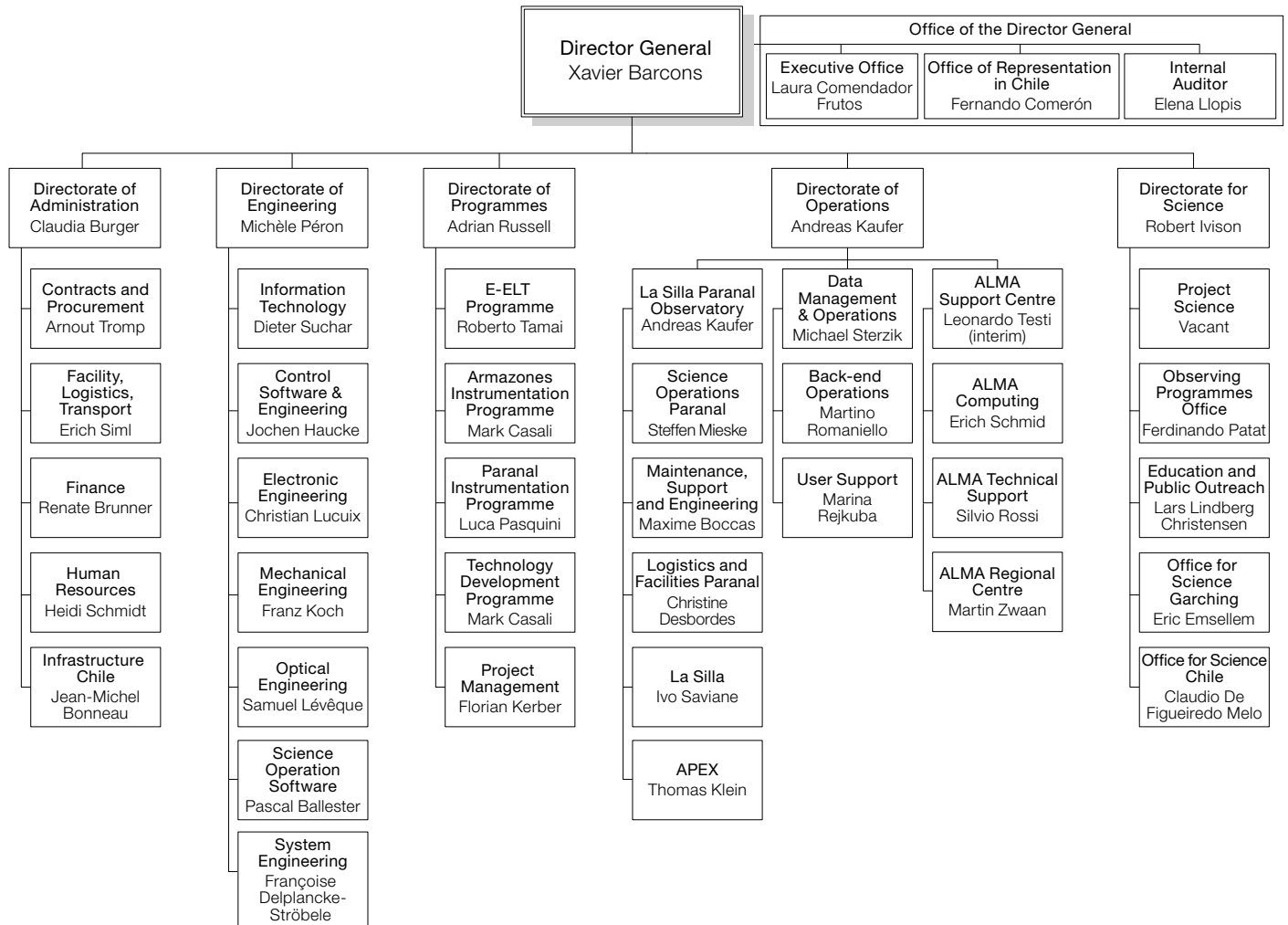

The entrance of the Paranal Residencia at night, illuminated by the Milky Way.



Office of the Director General



ESO/M. Zamani



ESO/M. Zamani

In October 2017, the Office of the Director General (ODG) was set up to consolidate various activities that are under the direct authority of the Director General (i.e., not delegated to the Directors), including corporate and horizontal activities across all Directorates. The ODG includes those activities previously carried out by the Cabinet of the Director General, as well as Internal Audit and the Representation in Chile, and is organised as described below.

Executive Office (ODG-X)

This supports the Director General with his internal and external duties and includes the following units:

- The Legal and Institutional Affairs (LIA) unit advises and assists the Director General with matters concerning the Organisation's institutional relations, protocol and diplomacy, defends ESO's legal interests, and provides legal advice.
- The Internal Communication Office (ICO) is responsible for strengthening and coordinating internal communication, ensuring that ESO staff have access to accurate and timely organisational information and encouraging communication and information sharing across the entire Organisation.
- The Corporate Policies & Risks Management (CPRM) unit deals with corporate risk management, personal data protection, data classification, corporate policies, and intellectual property matters, including technology and knowledge protection and licensing.

ODG-X also supports Council with the development and implementation of ESO's strategy when required and provides executive and secretarial support to the Director General, Council, the Directors' Team, and other auxiliary bodies. It is also responsible for editing the ESO Annual Report, The Messenger and the ESO Science Newsletter.

On 1 September 2017, Xavier Barcons (lower image) became ESO's eighth Director General, succeeding Tim de Zeeuw (upper image) who has served since 2007. Both stand in front of the prototype mirror segment for the ELT, which was signed in 2012 by all of the ESO Member States at the time.

Representation in Chile (ODG-R)

ODG-R represents ESO and the Director General in interactions with the Chilean governmental, regional and local authorities, as well as with diplomatic missions in Chile. It coordinates the representation of ESO's political and legal interests in Chile and promotes ESO's positive relationship with Chile at all levels — government, research organisations, universities, and society at large.

In October 2017, an International Relations Team (IRT) was set up, with the following goals:

- formulating ESO's policy in international relations, in line with guidance set out by the ESO Council;
- organising and coordinating relations with Member States and their national science communities as well as with prospective Member States or partners and international scientific organisations;
- promoting the ESO programme within the international scientific community;
- Representing ESO in various external bodies and boards.

The IRT is chaired by the Director General and includes two senior astronomers from the Directorate for Science (including the Director for Science), two members from the LIA (including its head) and the ESO Representative in Chile.

Internal Audit Office (ODG-A)

ODG-A reviews the reliability and integrity of financial information, the efficiency and economy of resource management, and compliance with ESO's rules and regulations. It carries out an independent, objective assurance and consulting activity designed to add value and improve the Organisation's operations and was established to assist all levels of management in the Organisation, as well as to support external auditors. Although reporting to the Director General, the Head of ODG-A also has a direct line to the Council President, in particular when dealing with audits affecting the Director General or the ODG.

Legal and Institutional Affairs

In 2017, one of the major focuses of the LIA office was the CTA project; ESO attends the CTA Council meetings as an observer. Discussions on the status of CTA in Chile, the scientific and technical collaborations between the project and Chile, and the establishment of an ERIC (European Research Infrastructure Organisation) as the legal entity for CTA and ESO's participation in it, continued to progress throughout the year.

Along with the finalisation of the agreement on the extension of the APEX project, which was signed in May 2017, the LIA office assisted the Director of the LPO with drafting, negotiating and finalising several agreements to host other scientific projects in Chile. Agreements were signed with the following bodies: ESA for the Test Bed Telescope; the German Space Agency (DLR) for a project to analyse OH airglow; and NOVA for the BlackGEM project, a wide-field telescope array aiming to follow up gravitational wave detections. Agreements were also reached to install the ULTRACAM instrument at the NTT and for a small solar telescope for the HARPS instrument.

As one of the steps towards the implementation of an ALMA Trilateral Agreement, the East Asian Executive NAOJ was incorporated as a shareholder in the Chilean company holding the ALMA concessions alongside ESO and the North American Executive, Association of Universities Inc. (AUI).

In Chile, the decree for the enlargement of the Area of Scientific Interest at Armazones was issued and published on 14 September 2017. With this milestone, the complete area for the ELT is now officially registered as protected against mining-related activities. On the other hand, some areas surrounding La Silla that were previously used for an airstrip, but had since fallen into disuse, have been returned to Chile in order to build a photovoltaic plant.

As in previous years, the LIA supported the Human Resources, Finance, and the Contracts and Procurement departments with various legal matters. The



In May 2017, in a ceremony at Chalmers University of Technology in Gothenburg, an extension of the agreement between the partners of the APEX was signed, ensuring that this very productive collaboration will continue until the end of 2022.

ongoing review of the rules for Local Staff Members in Chile should be highlighted, as well as contractual questions, particularly those regarding financing and procurement contracts for the ELT.

Signature ceremony with SCHOTT for ELT primary mirror segment blanks. Tim de Zeeuw, ESO's Director General, appears in the centre, with Thomas Westerhoff, Director Strategic Marketing Zerodur for SCHOTT, to the left and Christoph Fark, Executive Vice President Advanced Optics of SCHOTT, on the right.

Internal Communication Office

The Internal Communication Office (ICO) continued to produce, edit and publish ESO internal announcements and the weekly internal newsletter, the newsletter serving as the official channel for internal ESO-wide news. Approximately 400 announcements were published during the year. In collaboration with the ELT Programme, ICO introduced a new series of regular internal updates regarding ELT construction, covering not just big milestones, but also the equally important background work, in order to keep all staff aware of the latest news from this key programme.

The ESO Annual Overview 2017 was organised by ICO from 13 to 15 March

2017 across all sites, with the theme: "Challenges and opportunities in the context of the ESO Long-Term Perspectives". In a series of talks over three half-days, speakers from across the Organisation discussed the challenges and opportunities that ESO will face over the next fifteen years, considering the programme set out in the Long-Term Perspectives document. The topics covered a broad range of scientific, technical, operational and administrative areas. The talks were accessible to a wide audience, not only experts. As part of the event, staff in Garching enjoyed a screening of the movie "MUSE — the cosmic time machine", with a second screening arranged in Vitacura later in the year.

ICO, working with other colleagues in Garching, led the organisation of the conference: "Reaching New Heights in Astronomy — Celebrating ESO's achievements and perspectives from 10 years of Tim de Zeeuw as Director General", on the occasion of Tim de Zeeuw's departure from ESO. The conference took place between 28 and 30 August 2017, with over 20 high-level speakers giving talks on topics ranging from ESO's programmes to ESO's connections with the wider scientific landscape and including results from the forefront of astronomical research. The conference dinner was particularly special as it included a party for all ESO staff.

Signature ceremony with Safran Reosc for production of ELT primary mirror segments. Tim de Zeeuw, ESO's Director General, appears on the right and Philippe Rioufreyt, Chief Executive Officer, Safran Reosc, on the left.

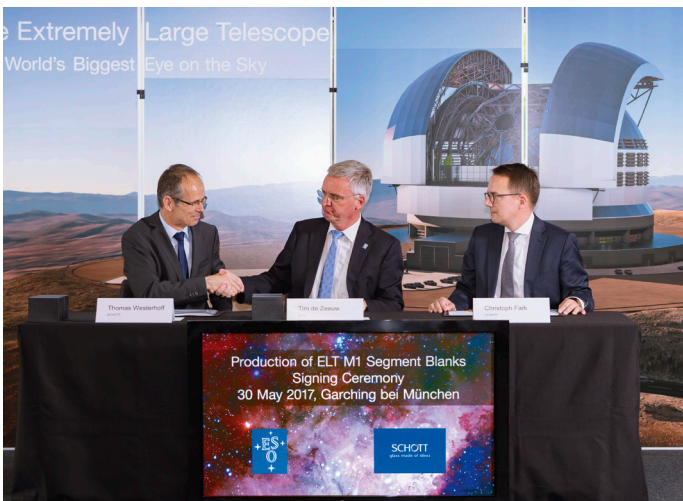



Group photo of the participants in the conference "Reaching New Heights in Astronomy 2017 — Celebrating ESO's achievements and perspectives from 10 years of Tim de Zeeuw as Director General".

A series of Spanish talks called "Astronomy for Everyone" and aimed at a general internal audience continued in Vitacura in 2017. In addition, the popular "What ESO Really Does" series of informal staff talks was restarted in Garching, with the first presentation entitled, "Engineering of the 39-metre Segmented ELT Primary Mirror".

For the second year in a row, ICO supported the internal contest "Stories from the Stars", in which staff based in Chile practised their writing skills by entering very short stories of up to 100 words on themes inspired by ESO.

Corporate Policies & Risks Management

In 2017, one of the most demanding areas for the Corporate Policies & Risks Management (CPRM) unit — called Risk and IP Management until September 2017 — was the management of ESO's intellectual property (IP). ESO follows a conservative but successful strategy in this area by protecting and licensing its in-house developments while evaluating the cost to benefit ratio. In 2017, the main addition to the ESO IP portfolio was a patent application covering a support system with earthquake protection technology. More information about ESO's IP management is available via the following website: <http://www.eso.org/public/industry/techtrans/>.

Regarding corporate policies, in 2017 ESO continued to work on the development of personal data protection, fraud prevention, and conflict-of-interest rules for the Organisation. To ensure diversity and inclusion within ESO, a working group was set up to develop strategy and recommendations for implementation (p. 116), and another working group delivered a report on the concept of an Ombuds at ESO, at the request of the ESO Director General, Xavier Barcons.

Corporate risk management focuses on the maintenance of the Corporate Risk Register. The ESO middle management were involved in delivering information about risks and opportunities to the ESO Directors in 2017.

ESO maintains a set of non-life insurance policies, with the support of an insurance

broker company. The current contract with the insurance broker runs out in 2018, so ESO published a competitive tender in 2017 to find a new broker.

International Affairs

2017 saw several highlights related to international relations at ESO. On 11 July 2017, an Arrangement was signed to begin a ten-year strategic partnership between Australia and ESO. The signature ceremony involved Australia's Minister for Industry, Innovation and Science, Arthur Sinodinos and ESO's Director General, Tim de Zeeuw. It was held at the Australian National University in Canberra during the annual meeting of the Astronomical Society of Australia. This strategic partnership gives Australia access to the LPO for ten years as well as the same



ESO's Director General, Xavier Barcons (left), met the European Commissioner for Research, Science and Innovation, Carlos Moedas (right).

benefits as a Member State with respect to LPO matters only. The Arrangement also notes the intention of both parties to pursue Australian membership of ESO in the future. Australian representatives were also appointed to the ESO governing bodies, Council, FC, the Scientific Technical Committee (STC) and the UC, and have participated in the corresponding meetings.

Another highlight was the announcement on 10 Oct 2017 by the Irish Deputy Prime Minister and Minister for Business, Enterprise and Innovation, Frances Fitzgerald, of her government's commitment to join ESO as a Member State. The intention is to join towards the end of 2018 after the ratification by the Irish parliament and approval by the ESO Council. ODG staff engaged with Irish astronomers and Department of Business, Enterprise and Innovation (DBEI) officials to begin the accession process and entry negotiations. Teams were appointed from ESO management and Council, and DBEI, to begin formal negotiations in January 2018.

Progress was also achieved in respect of other prospective Member States. In June 2017, the Norwegian Research Council finalised their evaluation of a proposal to join ESO, submitted by the University of Oslo in 2016. The Research Council ultimately judged — despite a very positive recommendation from an expert scientific panel — that Norway should not join ESO until such time as there is a larger astronomical community in the country. ODG staff have continued discussions with the Norwegian astronomical community to look for opportunities for involvement with ESO.

ODG staff prepared a series of options to provide clarity on the accession process of Brazil, which were presented to Council by the Director General on 6 December 2017. The ESO Executive will continue to work with Council in early 2018 to reach a satisfactory solution. Discussions continued with Hungarian astronomers, and the Director of Konkoly Observatory visited ESO Headquarters on 4 October 2017 to meet the new Director General and report on progress. The astronomical community made an application to the Hungarian National Research, Development and Innovation Office requesting support for



Left: Ceremony in Canberra, Australia, where a ten-year strategic partnership between ESO and Australia was signed. The Australian Minister for Industry, Innovation and Science, Arthur Sinodinos appears on the left and ESO's Director General, Tim de Zeeuw on the right.

Below: On Thursday 20 July 2017, the Australian flag was flying at the Headquarters in Garching for a visit to ESO by representatives of the Australian Department of Industry, Innovation and Science (DIIS), as well as the Australian Embassies in Berlin and Brussels.



ESO accession and it continues to seek additional funding.

ODG staff and the Director for Science attended the 2017 ASTRONET board meeting. ASTRONET is a strategic coordination mechanism for astronomy in Europe and is preparing to develop the next European Science Vision and Infrastructure Roadmap for Astronomy, following on from the success of the original 2007 version, which was updated in 2013. On behalf of ASTRONET, ODG staff also led the development of a position paper on the future of European Union astronomy funding. ESO's Director General delivered the paper to the EU Commissioner for Research, Science and Innovation Carlos Moedas on 19 December 2017 in Brussels.

ESO is an observer on the Astroparticle Physics European Consortium (APPEC). ODG staff attended APPEC Board meetings to support the development of the APPEC roadmap — the European Strategy for Astroparticle Physics — which is planned for release in 2018. The roadmap lists CTA as a high priority.

ESO was represented at meetings of the United Nations Committee on the Peaceful Uses of Outer Space in February and June 2017, during which ESO supported an IAU initiative on protecting the "Dark and Quiet Skies". ESO also supported activities related to the International Asteroid Warning Network and the Space Missions Planning Advisory Group.

ESO held the chairmanship of EIROforum until July 2017. In that capacity, ODG



Distinguished guests at the ELT First Stone ceremony. From left to right, Roberto Tamai (ELT Programme Manager at ESO), Paolo Astaldi (Chairman of Astaldi), Tim de Zeeuw (ESO Director General), Michelle Bachelet (President of the Republic of Chile), and María Teresa Ruiz (President of the Chilean Academy of Sciences).

staff organised the May bi-annual EIROforum DG Assembly, at which the Directors General, or equivalent, of the eight EIROforum organisations convene to discuss areas of shared interest and common challenges. The DG Assembly took place in Brussels on 11 and 12 May 2017 and was also attended by Commissioner Moedas; several key papers on European research infrastructure policy were presented. A further EIROforum DG Assembly took place in Heidelberg in November 2017 at which an EIROforum position paper on the next European Union framework programme funding (FP9) was discussed and approved for release.

On 16 March 2017, ESO held a consular visit day, which was attended by more than thirty consular representatives from diplomatic missions based in Bavaria. The aim of the visit was to raise ESO's visibility and to ensure that when politicians and decision makers from various countries visit Bavaria, the ESO Headquarters is included in their tour. The consular visit day also yielded several useful connections related to potential Member States.

Activities in Chile

The Representation in Chile coordinated activities around the ELT First Stone ceremony

that took place on 26 May 2017 in the presence of the President of the Republic of Chile, Michelle Bachelet, who had expressed a strong personal interest in participating. The ceremony was attended by more than 200 guests, including three ministers of the Chilean Government and other high-level government and academic authorities, twelve ambassadors from ESO Member States and three former ESO Directors General, as well as members of ESO's governing bodies, government officials of Member States, leaders of major observatories and astronomical organisations, and managers of companies that are key to the construction of the ELT. The ceremony was covered and reported in both the national and international media.

The importance of ESO observatories as a showcase of European and international cooperation continues to be highlighted by visits by officials of Member States and the Host State Chile to Paranal. In 2017 these included visits by: the President of the Senate of the Czech Republic Milan Štěch; the Chilean Minister of Energy Andrés Rebolledo, when the connection of Paranal and Armazones to the power grid was inaugurated; and the Director General of Foreign Policy at the Chilean Ministry of Foreign Affairs Milenko Skoknic. ESO also hosted a visit to ALMA by the Director General of Ceremonial and Protocol of the Ministry of Foreign Affairs, Gloria Navarrete. In addition, the ESO offices in Santiago were visited by a delegation of seven members of the Committee of Industry, Research and Energy of the European Parliament, which



Chile's Minister of Energy, Andrés Rebolledo (second from the right in the picture) at the ceremony to mark the connection of ESO's Paranal and Armazones sites to the Chilean national electricity grid.

led to a lively exchange on the societal role of astronomy and the role played by astronomical observatories in the development of science in Chile.

In 2017 there was progress towards the establishment of CTA-South in Paranal. This requires an agreement between ESO and the Government of Chile to recognise the status of CTA-South as a facility of the Paranal Observatory in order to qualify for the special conditions under which ESO operates in its Host State Chile. These discussions are continuing between ESO and the Chilean Government.

Chile is in the process of incorporating astro-tourism as one of the elements with which to promote the country's image worldwide, involving the international observatories that it hosts. This is closely linked to the perennial issue of the protection of sky quality, for which ESO provides support to the Chilean Government's initiatives through United Nations agencies. ESO has been working closely with the Chilean government, other international observatories, and public and private institutions in both of these areas.

Cooperation with Chile continues through several support programmes, most notably the popular fund managed by the ESO-Chile Joint Committee for the development of astronomy, which continues to receive a large number of applications

(52 in 2017) for the implementation of projects ranging from academic research to engineering and outreach.

Internal Audit Office (ODG-A)

During 2017, the Internal Audit Office provided support to the external auditors in the performance of their duties and in the delivery of reports to the ESO governing bodies. Another regular activity included the preparation of audit certificates for ESO partners. The Internal Audit Office also performed several other audits, including the audit of HR-related contracts and an IT security audit, which included a penetration test to evaluate the security of ESO's ERP system.

Safety

Safety actively supported the ELT project in 2017, focusing on the preparations for construction on site, and conducting design reviews and follow up on prevention, safety and compliance. This, together with the compilation of the system-wide ELT hazard and risk analysis, was very much a cross-departmental effort, where different directorates and disciplines contributed their expertise in general safety, electrical engineering, fire protection and much more.

Ongoing prevention activities consisted of defining new safety procedures and updating them where necessary. In particular, the increasing use of lasers at Paranal in 2017 required new safety procedures and the formation of a laser safety committee that will improve coordination and communication, from design and manufacturing through to installation and operation.

Other ongoing activities included designing and delivering appropriate training and drills (for example, fire drills), conducting and following up on-site inspections, audits and tests. Concrete improvements as a result of these activities included protecting against falls in telescope accesses, fire prevention in the oil tanks of the hydraulic bearing system of UT1 — currently being extended to the other UTs — and extra lighting in the VLTI tunnel and in the new Supernova building.

Regarding ALMA, ESO chaired the ALMA Safety Advisory Group (ASAG) between 2016 and 2017. ASAG advises the ALMA Director and the ALMA Directors Council on safety, security and environment-related issues and improvements. Their input was particularly solicited in respect of an increase in vehicular accidents and site clearance activities to dismantle temporary structures and upgrade the operational infrastructure.

The incident and accident figures for all sites in 2017 remained well below those of similar research institutions. ESO's commitment to safety, combined with its modern infrastructure and good state of maintenance largely contributed to this satisfactory situation. However, there is no room for complacency; while the efforts at office sites focus on preventing incidents on the way to work, operational sites continuously monitor the risks of slips and falls and, in the case of ALMA, the traffic on the mountain road. Furthermore, given the ramping up of construction activities at Paranal, Armazones and La Silla, it will be a challenge to maintain these low numbers in the next years.

An ongoing challenge regarding safety at ESO, as with any other organisation, is that of communication, awareness and compliance. In particular, in an international setting where there is not an exact application of national legislation, this entails a large effort centred on communication, documentation and training. Safety works on this continuously, providing appropriate guidance and argumentation at all sites to further raise the levels of prevention. With the Director General accepting the role of Chair of the ESO Safety Commission in 2017, ESO will take a significant step forward in the implementation and integration of safety in its corporate culture. In 2018, Safety will continue to support ESO programmes — the ELT is the most prominent of these — but not at the expense of other, smaller projects. Safety will moreover continue efforts to raise the standards of preparedness, safety, environment and security at all sites in Germany and Chile.

The VLT starts its nightly observations.





Organisational Matters



As its main governing body, the ESO Council determines the policy of the Organisation regarding scientific, technical and administrative matters. Both Council and the Committee of Council (CoC) (the informal body of Council) normally meet twice a year. However, in 2017, there was a need for two additional extraordinary Council meetings in July and October. Both ordinary Council meetings took place in Garching on 31 May–1 June and 6–7 December. The first of the CoC meetings was held in Prague on 7–8 March where the delegates were welcomed by their Czech colleagues. At the second CoC meeting, delegates were invited by the French delegation to the Centre National d'Études Spatiales (CNES) Headquarters in Paris on 10–11 October; this was also the first meeting attended by the new Director General, Xavier Barcons. All meetings were chaired by the Council President, Patrick Roche.

At the June meeting, the Council President and the ESO Director General provided an update on a range of ongoing events and actions, and the respective Directors and Heads of Department presented feedback on all aspects of ESO's programme, including the status of La Silla Paranal, the ELT and ALMA. Regarding the ELT, a proposed resolution was reviewed, resulting in Council's authorising ESO — and, by implication, the four instrument consortia — to proceed on the assumption that all ELT M1 segments (including the inner five rings and seventh sector), as well as the second M1 coating unit, would be in place at first light. Council was delighted to approve unanimously the initiation of a strategic partnership with Australia for 10 years.

A presentation on the CERN Pension Fund was given by Marcus Klug, the Council appointee of the Governing Board of the CERN Pension Fund. The Annual Report was approved, as were the Financial Statements for 2016 and the scale of contributions for 2018. The incoming external auditors, from Finland, were welcomed

and the External Audit Report approved, with discharge being granted to the Director General. To end the meeting, a presentation was made to Tim de Zeeuw, who was attending his last Council meeting as ESO Director General. His achievements over the past 10 years resulted in ESO's having the best facilities available and Council expressed their gratitude for his many accomplishments.

The final meeting of the year took place in Garching and a warm welcome was extended to the Australian representatives, who were attending their first Council meeting as observers. The meeting commenced with regular updates on the ESO programme. After reviewing the financial plan and receiving a status report from the Chair of the ELT Management Advisory Committee, Council authorised additional spending to cover the cost of the inner five rings of segments for the primary mirror of the ELT, as well as a set of 133 spare mirror segments (one sixth of the total M1), and an additional M1 mirror segment coating unit. Approval was given for the ESO Budget 2018 and Forward Look 2019–2021 within discussions related to finance.

Elections took place for the appointment of personnel to various ESO Committees, including the ALMA Board, Finance Committee, Observing Programmes Committee, Scientific Technical Committee and the Tripartite Group. This meeting marked the completion of Patrick Roche's and Jan Palouš's tenure as Council President and Vice President respectively, and Council elected Willy Benz and Catarina Sahlberg to these positions, with effect from 1 January 2018. Delegates also took the occasion to meet their national staff members at ESO, with the Council President joining those personnel who were not Member State nationals. A presentation was made to Patrick Roche on his departure and both Council and ESO expressed their gratitude for his dedicated and effective leadership over the past three years.

Council and Committee of Council 2017

President	Patrick Roche (UK)
Austria	João Alves Daniel Weselka
Belgium	Sophie Pireaux Christoffel Waelkens
Czech Republic	Jan Buriánek Jan Palouš (Vice President)
Denmark	Uffe Jørgensen/Allan Hornstrup René Michelsen
Finland	Anna Kalliomäki Jari Kotilainen
France	Denis Mourard/Guy Perrin Laurent Vigroux
Germany	Thomas Roth Linda Tacconi
Italy	Nicolò D'Amico Matteo Pardo
The Netherlands	Konrad Kuijken Mirjam Lieshout-Vijverberg
Poland	Konrad Dębski Marek Sarna
Portugal	Paulo Ferrão Paulo Garcia
Spain	Rafael Bachiller Inmaculada Figueroa
Sweden	Hans Olofsson Catarina Sahlberg
Switzerland	Willy Benz Bruno Moor
United Kingdom	Simon Morris Colin Vincent
Observers	
Australia	Matthew Colless Sue Weston (as of September 2017)

The flags of the ESO Member States, at the entrance to the ESO Headquarters in Garching, near Munich (Germany).

Finance Committee 2017

Chair	Inmaculada Figueroa (Spain)
Austria	Sabine Hertgen
Belgium	Alain Heynen
Czech Republic	Pavel Křeček
Denmark	René Michelsen
Finland	Sirpa Nummila (Vice-chair)
France	Anne-Hélène Bouillon
Germany	Gisela Schmitz-DuMont Bastian Rottländer (as of August 2017)
Italy	Salvatore Vizzini
The Netherlands	Thijs Geurts
Poland	Konrad Dębski
Portugal	Filipa Batista Coelho
Spain	Fernando Mérida
Sweden	Katrin Brandt
Switzerland	Astrid Vassella
United Kingdom	Maggie Collick
Observer	
Australia	Brad Medland (as of August 2017)

The ESO FC has overall responsibility for advising Council on all matters of administrative and financial management. In 2017, it held one extraordinary meeting and two ordinary meetings. All meetings were held in Garching and chaired by Inmaculada Figueroa. At the meetings, the FC received information on recent developments at ESO, including CERN Pension Fund matters and the procurement statistics and industrial return coefficients.

Australia nominated an observer, Brad Medland, to the FC after the conclusion of the arrangement of a strategic partnership with Australia in July.

At its 148th meeting in May, the FC approved several contracts, including a contract for the publication of the *Astronomy & Astrophysics* journal (A&A). On the first day of the meeting, the delegates visited the Technical Building and were given an insight into the development work for the ELT. This was the last meeting for Tim de Zeeuw (Director General), Patrick Geeraert (Director of Administration) and Gisela Schmitz-DuMont (German delegate). The chair thanked them for their fruitful collaboration over the years.

The 149th extraordinary FC meeting in September was the first to be attended by an Australian observer and focused on the preparation of the 2018 budget.

At its 150th meeting in November, FC recommended several items for approval by Council, including the 2018 budget, the Adjustment of Remuneration for ESO International Staff for 2018, a financial plan for the procurement of the full primary mirror (M1) of the ELT, the addition of the “Best Value for Money” policy as an alternative method to the “Lowest Compliant Tender” in procurement and the extension of the progressive retirement programme by another year.

In total, the FC approved 18 contracts exceeding 500 000 euros, ten amendments to existing contracts and six single-source procurements exceeding 250 000 euros. Two of the contracts and one amendment were approved by written procedure.

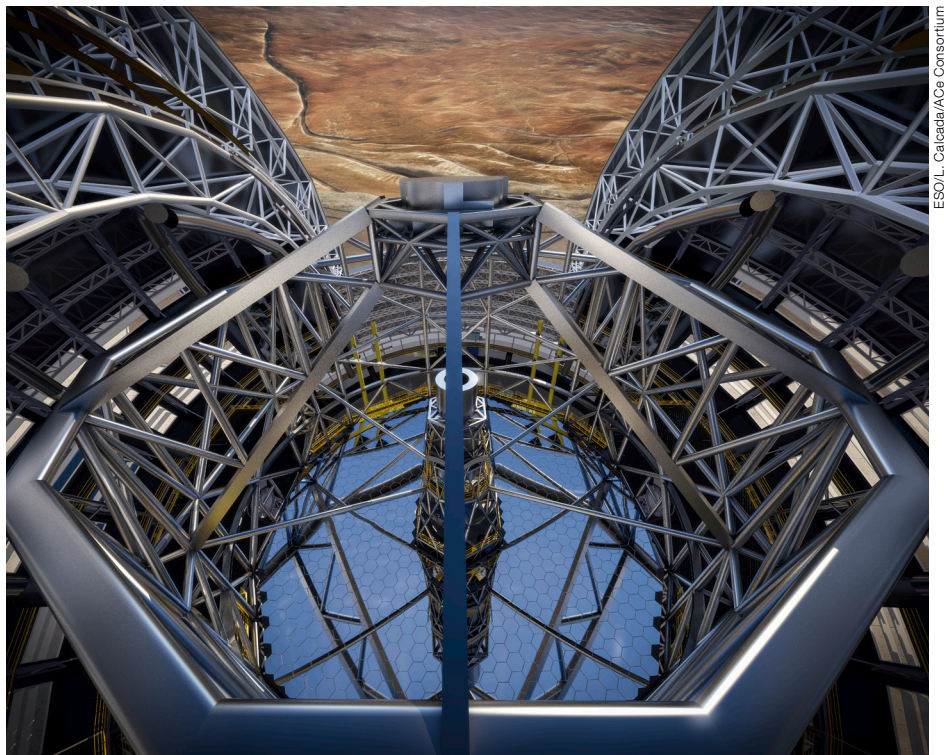

This artist's rendering of ESO's Extremely Large Telescope (ELT) is based on the detailed construction design for the telescope.

ESO/L. Calçada/ACE Consortium

Scientific Technical Committee

The Scientific Technical Committee 2017

Chair	Sofia Feltzing (Sweden)
Austria	Franz Kerschbaum
Belgium	Hans Van Winckel (LSP)
Czech Republic	Pavel Jáchym
Denmark	Jes K. Jørgensen (ESAC)
Finland	Alexis Finoguenov (LSP)
France	Anne-Marie Lagrange (ESC, Chair)
Germany	Matthias Steinmetz (ESC)
Italy	Livia Origlia
The Netherlands	Eline Tolstoy (LSP)
Poland	Grzegorz Pietrzyński
Portugal	André Moitinho (LSP)
Spain	Almudena Alonso-Herrero (ESC)
Switzerland	Francesco Pepe
United Kingdom	Ian Smail (ESAC)
Chile	Neil Nagar

Members at Large

Warrick Couch (Australia)
 John D. Monnier (USA, LSP Chair)
 Eva Schinnerer (Germany, ESAC Chair)
 Gillian Wright (UK, LSP)

Observer

Australia Michael Ireland (as of October 2017)

The STC advises Council and the Director General on scientific and technical priorities for ESO's projects and programmes. Much of the STC's work is done in sub-committees, including the European Science Advisory Committee (ESAC) for ALMA, the La Silla Paranal committee (LSP) for LPO and the ELT sub-committee (ESC). These sub-committees meet two weeks before each STC meeting, enabling a greater focus on specific topics, and increasing the amount available for discussions during the main meeting.

89th STC meeting

The 89th meeting of the STC was like no other in recent memory; the meeting was held on Paranal over 23–24 April 2017 with the majority of the STC's 21 members, members at large, and observers in attendance.

Despite their familiarity with ESO, this was the first opportunity for many of the participants to see the extraordinary team effort that is required to produce the data for the astronomical community. Guided by the LPO Director, the VLTI Programme Scientist and the ESO Director General, the STC witnessed the precision of the VLTI delay lines, the complexity of the MUSE instrument, the breathtaking sunset on the Paranal platform, and the beauty of the four lasers of the AOF in operation at the beginning of the night.

STC members also spent time in the control room, talking with ESO staff astronomers, postdoctoral fellows and visiting astronomers. Two fellows, Elizabeth Bartlett (ESO Chile Fellow) and Hugo Messias (JAO Fellow) had the chance to share their experiences as fellows in Chile.

The meeting began with a presentation by Tim de Zeeuw, attending his last STC meeting as ESO Director General. He covered the most recent developments of the ESO programme, setting the stage for detailed presentations by ESO colleagues reporting on specific areas.

The STC heard that the ELT programme was moving ahead at full speed. Several contracts for critical components had been signed recently and work was ongoing on a number of subsystems. Instru-

ment consortia for the first-light instruments, MICADO and HARMONI, were working steadily towards PDR. The focus of the meeting was firmly on the M1 mirror; the two-part phased approach for its construction had been found to impose an extra burden on ESO and the instrument teams, who had to consider two M1 options in their designs. There was strong support for a proposal to remove this uncertainty.

ALMA continued to showcase impressive results in a range of fascinating areas including the early Universe, stellar physics and planetary formation. The STC was told how ALMA had joined a worldwide VLBI campaign in April 2017 to observe the Galactic Centre with unprecedented resolution. The data from all sites were in the process of being correlated and analysed and results were expected later in 2017.

Overall, ALMA data reduction and quality assurance were reported to be proceeding smoothly. While operations were ramping up, technological developments in the area of the receivers had also been remarkable, and were being incorporated into the new Band 5 and the proposed Band 2+3. Ambitious upgrades of the array, receivers and amplifiers were also discussed to ensure the Observatory remains state of the art.

The latest developments at the LPO (which includes Paranal, La Silla and APEX) were also showcased at the STC. Once more, GRAVITY had exceeded expectations. The AOF had been successfully commissioned and science exploitation — first with MUSE and later with HAWK-I — was due to start in the second semester of 2017. New web-based preparation tools had been deployed at Paranal to enhance the user experience, to allow much more flexible planning of observations and to prepare for ELT operations.

Despite these impressive results there was no time to rest; a clear roadmap for the VLTI was presented, with exciting prospects for the short- and long-term future of interferometry at ESO. With all the VLT foci being used, the VLT Programme Scientist, Bruno Leibundgut, and colleagues were considering the future of LPO instrumentation, including upgrades that would keep ESO's instruments

competitive, instruments that should be decommissioned to make room for new ones and new instrumentation that would have the greatest impact. Discussions continued on these themes and how these puzzles could be solved while keeping the ELT as the top priority in ESO's programme. While substantial work is starting on the infrastructure at Paranal in preparation for the ELT and CTA, the Observatory faces the challenge of maintaining state-of-the-art operations while also being an active construction site.

Even ESO's world-class telescopes and instruments cannot do great science if they do not attract exciting proposals from ESO's astronomical community. A lively discussion took place when Ferdinando Patat of the Observing Programmes Office presented a set of innovative ideas to the STC, which were originally proposed to the Director for Science by the Time Allocation Working Group (TAWG), to improve the ways that astronomers request time on ESO facilities.

The meeting finished at noon on 24 April, before which the Chair of the STC thanked the ESO Director General on behalf of the STC for his remarkable leadership during the last 10 years. However, the STC's visit was far from over. The whole group then headed to Cerro Armazones, the home of the ELT. On the way up, they saw the substation that will connect Paranal, Armazones and CTA to the Chilean electricity grid. Up there on the ELT platform, with Paranal in the distance, it was impossible not to imagine the exciting times ahead and the future breakthroughs that the ELT will enable.

From Armazones, members of the STC made their way to San Pedro de Atacama and to ALMA's OSF. Gianni Marconi gave them a tour of the Band 5 receiver integration laboratory and, for those who passed the high-altitude medical, the high site itself. While cold and windy, the sight of the ALMA 12-metre array in a compact configuration will stay in the visitors' memories forever.

90th STC meeting

As usual, the 90th STC meeting was preceded by sub-committee meetings for the ELT, ALMA and the LPO. The STC meeting itself, held in Garching on 24–25 October 2017, was chaired for the last time by Sofia Feltzing, and was the first meeting for Xavier Barcons as ESO Director General. This was also the first STC meeting to be attended by Michael Ireland (Australian National University) as an observer under Australia's strategic partnership with ESO.

The ELT team briefed the STC on progress over the previous six months, during which time the project has ramped up quickly in intensity. The "First Stone ceremony" had been held at Paranal Observatory on 26 May, at which point the site was handed over for the construction of the dome and telescope main structure. The ESO Council authorised work for the full M1 in June. On the instrumentation side, the three first-light instruments all had their PDRs scheduled over the next 12 months.

Members of the STC were pleased with the overall progress. A remaining concern for the future was the uncertainty around funding for the next instruments, as well as in equipping the second pre-focal station.

A status report on ALMA summarised the conclusions from the previous cycles and Cycle 4 that had just started. Progress had been made on observing programme completion rates, previously an area of concern. In addition, the backlog in data delivery had been overcome after a significant investment of resources. On the technical upgrade path, the ALMA Programme Scientist, Leonardo Testi, described progress with the future Band 2+3 receivers (due in full production between 2020 and 2022, if approved).

The ALMA programme was undergoing substantial personnel changes while operations matured; in addition to a new incoming ALMA director — Sean Dougherty (from April 2018) — ALMA was looking for three new senior positions, including Heads of Science Operations, Engineering and Data Management. The STC commended these positive developments and passed on a number of user concerns around data access and readiness.

The LPO overview highlighted several upgrade and remedy projects at Paranal. The most challenging aspect of the past semester had been the bad weather plaguing Chile and bringing 20–30% weather losses over various telescopes. A positive development was the restart of regular coating on Paranal, with all four VLT primary mirrors recoated over the previous year.

The STC noted that all second-generation VLT/VLTI instruments are now on Paranal. ESPRESSO and MATISSE and new observing modes (mostly associated with the adaptive secondary mirror) were powerful additions to the Observatory. Discussion of new projects included a preview of the next planned instrument: a visible-light adaptive optics system, which would be a first on an 8-metre telescope. In the meantime, La Silla is expecting the next "exoplanet machine" (NIRPS) and "transient machine" (SOXS), with both instruments headed to final design reviews. ESO also received two proposals for telescopes to be hosted on La Silla, of which one was recommended for approval: an ESA project aimed at detecting near-Earth objects and estimating the likelihood of their impact and potential consequences.

Finally, APEX was reported to be undergoing a shutdown for several months to be upgraded ahead of several more years of operations.

Observing Programmes Committee

The Observing Programmes Committee 2017

Suzanne Madden (Chair)
Timo Prusti (Vice-Chair)

Angela Bongiorno
Sylvain Bontemps
Christopher Conselice (P101)
Wolf-Rainer Hamann
Gerhard Hensler (P100)
Catherine Heymans
Peter Jonker (P100)
Kirsten Knudsen (P101)
Badri Krishnan
Elina Lindfors
Sebastian Lopez
Eduardo Martin (P100)
Joanna Mikolajewska (P100)
Subhanjoy Mohanty
Goeran Oestlin (P100)
Elena Pian (P101)
Philipp Richter
Roberto Saglia
Maurizio Salaris (P101)

During its meetings in May and November, the OPC evaluated the proposals submitted for observations to be executed in Periods 100 (1 October 2017 to 31 March 2018) and 101 (1 April to 30 September 2018). The numbers of proposals for observations with ESO telescopes in these two periods were 894 and 899, respectively.

The proportions of submitted proposals (excluding Large Programmes) were 20.1%, 19.4%, 29.6% and 30.9% for A, B, C and D categories, respectively. In terms of time requested, the proportions were 23.2%, 18.2%, 28.7% and 29.9%. This is in line with the slight shift towards stellar science (categories C and D) as compared to extragalactic science (categories A and B) that has been observed over the last few years. To rebalance the load between the A and B panels, the definitions of their subcategories were updated and deployed in Period 101.

The OPC categories are specified in full at <http://www.eso.org/sci/observing/phase1/opc-categories.html>.

In 2017, X-shooter, which is mounted on Kueyen (UT2), maintained its position as the VLT instrument with the largest amount of requested observing time (489 nights). It was followed by MUSE (419 nights) on Melipal (UT4), and by

FORS2 (376 nights) on Antu (UT1). Kueyen (UT2) continues to be the most popular UT, in terms of requested time (931 nights). The telescope with the highest ratio of requested to available time (8.38) is Melipal (UT4). The availability of UT4 in Periods 100 and 101 was low because of activities related to the AOF.

In 2017, demand for the new interferometric instrument GRAVITY, which was first offered in Period 99 with four UTs, significantly increased. The allocation was particularly large in Period 101, which covers the periastron passage of the star S2 around the Galactic Centre.

The OPC reviewed 13 open-time proposals for the VISTA survey telescope and 17 for the VST, of which 6 and 10 were scheduled, respectively.

On La Silla, HARPS and EFOSC2 continued to be in high demand.

No application was received by ESO within the framework of the continuing agreement between ESO and ESA for a joint telescope time allocation scheme for coordinated observations with the VLT and XMM-Newton. Time on both facilities was granted to one joint proposal evaluated by the XMM-Newton Observing Time Allocation Committee.



Members of the Observing Programmes Office pose for a photo at ESO Headquarters.

ESO/P. Herdlek

Targets of Opportunity

The number of Target of Opportunity proposals submitted in 2017 was similar to previous years. For Periods 100 and 101, the OPC evaluated 35 and 42 proposals, respectively, of which 18 and 22 were scheduled, amounting to a total of about 457 hours. FORS2 and X-shooter were the most requested instruments for Target of Opportunity observations, with a total of 429 requested hours. These two instruments were allocated 59.5% of the Target of Opportunity time. The Target of Opportunity allocation at the two survey telescopes for programmes dedicated to the identification of the counterparts of gravitational wave sources remained substantial (49 hours — 10.7%) and contributed significantly to the follow-up of the GW170817 event, for which time was successfully invested both at Paranal (VLT) and at La Silla (NTT).

Calibration Programmes

Calibration Programmes allow users to complement the existing coverage of the calibration of ESO instruments. Calibration Programmes are evaluated in the main by comparing the potential enhancement of the outcome of future science that can be expected from their execution with the immediate return from science proposals

in the current period that are directly competing for the same resources. In 2017 six Calibration Programmes were submitted (three each in Periods 100 and 101). Four proposals were recommended for implementation by the OPC (two each in Periods 100 and 101).

Large Programmes

Large Programmes are projects that require a minimum of 100 hours of observing time and that have the potential to lead to a major advance or breakthrough in the relevant field of study. Large Programme execution can be spread over several observing periods with a maximum duration of four years for observations to be carried out with the La Silla telescopes, and two years on the VLT/I and on APEX.

A total of 32 Large Programme proposals were received in 2017, 16 each in Periods 100 and 101. Out of these, three programmes were GTO Large Programmes from the Spectro-Polarimetric High-contrast Exoplanet REsearch (SPHERE) and MUSE instrument consortia.

Following the OPC recommendations, three new Large Programmes were implemented in Period 100, and seven in Period 101. The trend towards using a large fraction of science time on the

La Silla telescopes for the execution of Large Programmes, encouraged by ESO and already embraced by the community in recent years, has continued. The total allocations to new and ongoing Large Programmes in Periods 100 and 101 at the 3.6-metre telescope and at the NTT were 98.7 and 107.5 nights respectively. This corresponds to 29.5% and 33.5% of the available science time at these two telescopes.

Public Spectroscopic Surveys

The two spectroscopic surveys, VANDELS and LEGA-C (UT3+VIMOS) were completed in Period 100.

Director's Discretionary Time

Proposals asking for Director's Discretionary Time (DDT) may be submitted throughout the year for programmes that present a level of urgency incompatible with the regular proposal cycles handled by the OPC. In 2017, the ESO user community submitted 109 DDT proposals, requesting about 596 hours. After taking advice from an internal committee of ESO staff astronomers, the Director General approved 58 DDT proposals for implementation, amounting to a total of 240 hours.



Users Committee

The Users Committee 2017

Chair	Maria-Rosa Cioni (Germany)
Austria	Wolfgang Kausch
Belgium	Olivier Absil (Vice-chair)
Czech Republic	Michaela Kraus
Denmark	Lise Bech Christensen
Finland	Talvikki Hovatta
France	Nicolas Bouché
Italy	Maria Teresa Beltran
The Netherlands	Karina Caputi
Poland	Łukasz Wyrzykowski
Portugal	David Sobral
Spain	María Rosa Zapatero Osorio
Sweden	Sofia Ramstedt
Switzerland	Miroslava Dessauges
United Kingdom	Stephen Smartt
Chile	Thomas Puzia

The UC advises the ESO Director General on various operational aspects, such as performance, scientific access, operations and data management facilities, as well as on services offered by ESO to its users that are directly related to the LPO and ALMA. The UC members include one astronomer from each of the ESO Member States and Chile; they are in charge of channelling feedback from their national communities, communicating their respective communities' experiences of using ESO facilities and formulating specific recommendations for improvements. The UC held its 41st annual meeting at ESO Headquarters in Garching on 8–9 May and a mid-term teleconference on 17 November.

During its 41st meeting the UC was interested to hear results of an investigation of technical downtime statistics from Paranal, enquired about the various aspects of data processing and delivery of ALMA data, and encouraged ESO to continue placing a high priority on the development, support and improvement of pipelines. A new way of interacting with observers using eavesdropping — which allows users to follow their observations in real time — in combination with the new web-based Phase 2 preparation and visitor observing tools was showcased by means of a live demonstration via a connection with Paranal.

The UC expressed disappointment with the long timeline for the development of the new Phase 1 proposal submission tool and recommended the acceleration of its delivery in response to repeated requests for improvements from the community. The reports from the working groups on Science Data Management and Time Allocation were presented. The recommendations from the latter were discussed in relation to the results from a recent survey of non-publishing PIs. After the meeting, in September, the UC delivered to ESO consolidated written feedback on the two Working Group reports. While expressing overall support for the recommendations, the UC also had some reservations and expressed a degree of disagreement with some of the Time Allocation Working Group recommendations.

The second day of the UC annual meeting focused on Multi-Object Spectroscopy (MOS). Two expert users from the community, Barbara Lanzoni (Italy) and Christophe Adami (France) shared their experiences with several instruments (FLAMES, KMOS, FORS2 and VIMOS) all of which have MOS capabilities that have been crucial for their research. ESO presented the capabilities of current MOS instruments and forthcoming plans for 4MOST and MOONS operations, as well as the results from the MOS Working Group led by Richard Ellis.

The UC conveyed a high level of satisfaction overall within the community and the meeting concluded with the presentation of recommendations that were based in part on feedback collected from the UC poll. Progress on these recommendations was further discussed at the mid-term teleconference in November, in which the Australian observer for 2018, Caroline Foster, also participated.



Panorama showing the VISTA telescope in the foreground; the VLT can be seen in a distance, to the left.

International Staff Association

The origin of a staff association representing International Staff Members is embedded in the International Staff Rules Chapter VII entitled “Relations with the Personnel”. Article VII 1.02 in this chapter simply states, “A Staff Association may be established”. The primary function of this staff association is defined in the preceding article, which states “Within the framework of the present Rules, and independently of the normal hierarchical channels, the relations between the Director General of the Organisation and the members of the personnel shall be either direct with the individual or on a collective basis with the Staff Associations as intermediaries”.

At the moment the International Staff Association (ISA) is composed of two International Staff Committees, one representing staff in Europe (ISCE) and mainly located in Garching, and one for staff based in Chile (ISCC). A very large majority of the international staff — approximately 432 in total in 2017 — are paying members of the ISA; 426 members were registered as of September 2017, of whom 343 are based in Europe and 83 in Chile.

Based on these ESO Staff Rules, a further definition of how relations between the Director General and international staff are structured is described in the ESO Staff Regulations Chapter VII entitled “Relations with the Members of Personnel”. An essential body for establishing this relationship is introduced in this chapter, the Standing Advisory Committee (STAC). In 2017, important progress was made on renewing the role and functioning of this advisory body. Besides its participation in STAC, the ISA is represented at various other official entities, including:

- Finance Committee (FC);
- Tripartite Group;
- Joint Advisory Appeals Board;
- Indefinite Appointment Advisory Board;
- Rehabilitation Board;
- Disciplinary Board;
- CERN Pension Fund.

However, the role of the ISA is broader than that officially defined in the ESO Staff Rules and Regulations. Additional aims are mentioned in the ISA Statutes

Article 2:

- a) To promote the unity and cooperation between the various ESO establishments for the benefit of the whole organisation;
- b) To ensure that the working conditions of the staff are in accordance with the ESO Combined Staff Rules and the ESO Staff Regulations (SRR) and with all other instructions applicable to the staff, and to propose improvements to the SRR;
- c) To safeguard the rights and defend the interests of all members of the staff, especially as regards security of employment;
- d) To cooperate with the Director General and his representatives in the improvement of working conditions and, in this connection, to inform the Director General of the views and wishes of the staff;
- e) To strengthen the ties between the various nationalities represented in the Organisation;
- f) To set up any body and to provide services of any kind likely to promote the welfare of the staff, including cultural, social and sports activities;
- g) To cooperate with the Director General in promoting good relations with the local population among whom members of the staff and their families are living.

Within the framework of the above aims the ISA takes care, often with direct help from individual staff members, of organising regular social activities like the children’s Christmas party and summer party. Financial support is provided for other social activities, like sports events.

Besides these group activities the ISA, through the regional Staff Committees, also provides support to individual staff members, for example, if there are conflicts with the Organisation.

After an increasingly difficult period in 2016 and early 2017, resulting in the absence of a Staff Committee, the ISA General Assembly voted on 5 May 2017 to hold elections for ISA representatives again. The underlying objective was to have a new Staff Committee installed by the time the new Director General took up his position. These elections were held in September in both Chile and

Garching and resulted in a fresh ISC in each region. Staff transmitted a clear message, expressed by a voter participation of 86% (88% for ISCE and 78% for ISCC), giving the ISC a strong mandate to represent staff. On that same occasion staff recommended the following to the elected Staff Committee: to re-establish a good working relationship with the Director General elect and senior management, and to conclude the Recognition Agreement — based on concertation (which relies on open dialogue and discussion) — and establish STAC Rules of Procedure defining guidelines for this implementation.

In early October, the new ISC met the new Director General for the first time and agreed to collaborate on the aforementioned recommendations at the highest priority. As a result of this the Recognition Agreement was signed by the Director General and the president of the ISA on 5 December 2017. The corresponding STAC Rules of Procedure were drafted and submitted to STAC for review at their next meeting, to be held in January 2018.

Although the Director General and the ISC expressed an intention to resume a normal working relationship in 2017, it was not feasible to address various outstanding proposals by the STAC immediately because of time constraints. The process involves submitting these proposals to the Director General, obtaining recommendations from the FC and final approval by Council. However, the ISC is strongly committed to addressing these proposals in 2018 following the principle of concertation. The ISC aims for competitive working conditions for all staff to meet the challenges within the Organisation. It considers trust, solidarity, accountability, transparency and responsibility key elements to have empowered and engaged staff at ESO. The staff committee strives for a collaborative relationship with the Director General and his team to accomplish this vision. The ISA hopes that ESO’s governing bodies, the FC and Council support the agreed concertation process, giving a basis for a fair, contemporary governance of the relations between the Director General and staff.

Local Staff Representatives

The first steps towards staff representation were in the early days of ESO in Chile, when a group of Local Staff Members created a Staff Association called “Asociación Única del Personal Local” (AUPL). This association laid the foundation of the relationship between ESO and its Local Staff Members. In January 1998, the so-called “Book 1” came into force and gave the representation of the Local Staff Members the opportunity to have a new body as a legal and recognised union. The current regulations for local staff in Chile were released and implemented in April 2002.

Since November 2016, there have been two unions, the “Sindicato del Personal Local del Observatorio La Silla–ESO” and the “Sindicato de Técnicos y Profesionales del Personal Local del Observatorio Paranal–ESO”. Additionally, two staff delegates represent the “Group of Non-Unionized Local Staff Members”. Here is some more information about each of these.

Sindicato del Personal Local del Observatorio La Silla-ESO

The old AUPL, which had long represented mostly local staff at the La Silla Observatory, was succeeded by this organisation. It was established in September 2002, and in 2017, this union

had 37 members across ESO, 10 of whom were at the La Silla Observatory, 25 at the Paranal Observatory, and one each at APEX and at Vitacura. The new representatives of the union are all telescope operators at Paranal and were elected in August 2017. They are Carlos La Fuente (President); Marcelo Lopez (Secretary); Rodrigo Romero (Treasurer).

Sindicato de Técnicos y Profesionales del Personal Local del Observatorio Paranal–ESO

This union was founded in October 2002. In 2017, they had 69 members across ESO, 53 of whom were at the Paranal Observatory, 10 at APEX, and 6 in Vitacura. The director of the union is Fernando Salgado (electronics engineer at Paranal), the secretary is Nicolas Slusarenko (software engineer at Paranal) and the treasurer is Alex Correa (telescope operator at Paranal).

Group of Non-Unionized Local Staff Members

This consists of 45 Local Staff Members. The two staff delegates are Diego Rioseco (legal advisor at Vitacura) and Marcus Pavez (system administrator at Paranal).

The delegates from the three groups listed here represent their members through regular communication with the ESO management. They are all actively participating in the review of the Regulations for Local Staff (RPL) in Chile, a process that started in 2015. The final draft will be presented in 2018 and submitted to the Chilean government. A more detailed list of their activities in 2017 is provided below.

List of activities

- A contract for health insurance for union members and their families was signed with the Fundación Arturo López Pérez, which fights against cancer.
- Work is in progress regarding points from the 2016 bargaining process and involves several working groups related to various issues, for example, working clothes, night work, emergency transportation and medical assistance.
- Meetings with the new Director of Administration and the new Director General.
- Active participation in the Federation of Astronomical Observatories in Chile (Federación de Observatorios Astronómicos de Chile, FOACH). Fernando Salgado was elected Secretary of the board.
- Many staff members also appreciated the chance to meet the President of Chile, Michelle Bachelet, during her visit to Paranal in May 2017.



Paranal Union leaders pose with President Bachelet, after presenting her with a vase containing soil samples from the five ESO sites, during the First Stone event in the Paranal Residencia.

Diversity

It is one of ESO's objectives to advance diversity and inclusion at all levels within the Organisation by fostering a culture and atmosphere of mutual respect and promoting outstanding employees from all backgrounds, genders and cultures. In 2017, the Director General set up an internal committee, the Diversity and Inclusion Committee, to implement goals, policies and good practice around these issues. The committee integrates efforts from all parts of ESO and is responsible for developing and supporting the implementation of a diversity and inclusion plan around three pillars: recruitment and career development; creating a welcoming environment and culture; and working conditions.

Gender is an immediate focus of the committee, as the female representation in STEM jobs — in particular in engineering — remains very low. Priorities for the committee include raising the awareness of the importance of inclusion to achieve diversity as well as of the impact of unconscious bias on the workplace. In 2017, guidelines for the usage of gender inclusive pronouns were prepared, videos on unconscious bias to be used as training for selection boards were chosen, and talks on topics related to diversity and inclusion were planned for the following year. In addition, members of the committee continued to be active in a variety of networks and international working groups that promote diversity, gender equality, professional ethics and

inclusivity: for example, Girls' Day (p. 92), the European Commission-funded GENERA project, and the IAU working group Women in Astronomy.

In January, ESO, CERN and NordForsk organised a "Gender in Physics Day" to discuss the main challenges that intra-governmental organisations face in terms of gender equality and diversity. The one-day meeting was attended by all eight EIROforum organisations. One of its main outcomes was the start of an ad hoc Working Group on diversity and inclusiveness, whose main objectives are to provide a platform for sharing practices and benchmarking data, to combine forces in raising awareness within the organisations and prioritise key actions on these topics.



ESO Code of Conduct for Workshops and Conferences

ESO has a number of policies that define the ethical and behavioural standards expected of ESO staff. Several avenues are available to staff members, through which they can report problems related to violations of these policies. For confidential enquiries and complaints, a staff member can approach any one of the external and internal harassment contact persons and/or HR harassment advisors in Germany and Chile, each of whom is specially trained to support staff seeking help on ESO's policies and to advise them on their options.

In recent years the largest astronomical body, the IAU, along with every other major astronomical society, has issued recommendations for scientific meetings. Central to these recommendations is that a code of conduct should be published prominently at every meeting as every participant bears a responsibility to create a welcoming environment at the meeting. At the same time, organisers are expected to develop procedures to handle any violations of these codes of conduct. In 2017, in order to remain in line with current best practice and to protect all participants at ESO workshops and conferences (and not just ESO staff members), ESO developed a new code of conduct to apply to the many workshops and conferences held on ESO premises.

This code of conduct was devised using existing ESO policies, recommendations from the IAU and other societies, and guidelines developed for other recent astronomical workshops. It was finalised with input from ESO staff, and with the involvement of ESO's harassment advisors and harassment contact persons. Following a discussion by the Directors Team and approval by the Director General, the code of conduct will apply to ESO workshops and conferences in 2018. ESO will continue to follow developments across the STEM community so that it is well placed to update the code of conduct and associated procedures and stay in line with best practice.



ESO conferences and workshops attract scientists of all ages and from all over the world as seen in this photo of the participants in the workshop "The Impact of Binaries on Stellar Evolution", which took place at the ESO Headquarters from 3-7 July 2017.

Calendar of Events

January

ESO signs agreement with Breakthrough Initiatives to conduct a search for planets in the nearby star system, Alpha Centauri. ESO Headquarters, 9 January.

Four contracts signed for major components of ESO's ELT including the casting of the secondary and tertiary mirrors, and the supply of mirror cells and edge sensors. ESO Headquarters, 18 January.

ESO Calibration Workshop "The second-generation VLT instruments and friends". ESO Vitacura, 16–19 January.

February

ESO Workshop "Getting ready for ALMA Band 5 — Synergy with APEX/SEPIA". ESO Headquarters, 1–3 February.

March

ESO Workshop "Stellar populations in stellar clusters and dwarf galaxies — new astronomical and astrophysical challenges". ESO Vitacura, 2–3 March.

ESO Workshop "Star formation from Cores to Clusters". ESO Vitacura, 6–9 March.

VLTI Community Days. ESO Headquarters, 6–10 March.

Annual Overview (internal review), ESO: all sites, 13–15 March.

April

ALMA Board meeting. ALMA Santiago Central Office, 19–21 April.

89th STC meeting. ESO Headquarters, 23–24 April.

ALMA Residencia handed over to the Joint ALMA Observatory. ALMA Operations Support Facility, Chile, 25 April.

Girls' Day — part of a German nationwide event. ESO Headquarters, 27 April.



Above: The attendees at the 2017 Calibration Workshop in the garden at ESO Vitacura.

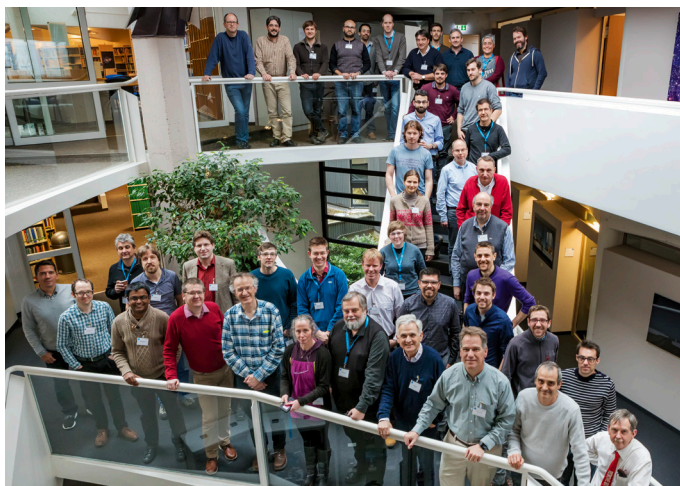

Left: Participants in the VLTI Community Days

May

148th FC meeting. ESO Headquarters, 3–4 May.

41st UC meeting. ESO Headquarters, 9–10 May.

100th OPC meeting. Abbazia Spineto, Italy, 16–18 May.

ELT tertiary mirror blank successfully cast by Schott, Mainz, Germany, 22 May.

First Stone ceremony with Chilean President Michelle Bachelet and over 200 distinguished guests, including high-level government and academic representatives, as well as twelve ambassadors from ESO Member States, 26 May.



The ALMA Residencia at the ALMA Operations Support Facility was handed over to the Joint ALMA Observatory. Here, the symbolic key to the building is being handed to the ALMA Director, Pierre Cox (left) by ESO's Director General, Tim de Zeeuw (right).

Contracts signed for the primary mirror of the ELT. ESO Headquarters, 30 May.

142nd Council meeting. ESO Headquarters, 31 May–1 June.

June

European Week of Astronomy and Space Science. Charles University, Czech Republic 26–30 June.

European Week of Astronomy and Space Science Special Session “The European ELT — Project status and plans for early science”. Charles University, Czech Republic, 29 June.

July

ESO Workshop “Impact of Binaries on Stellar Evolution”. ESO Headquarters, 3–7 July.

Australia enters strategic partnership with ESO. Canberra, 11 July.

ESO Workshop “Early Stages of Galaxy Cluster Formation 2017”. ESO Headquarters, 17–21 July.

ESO and Excellence Cluster Workshop “Galaxy Ecosystem — Flow of baryons through galaxies”. ESO Headquarters, 24–28 July.

August

First light with MUSE using the newly commissioned Adaptive Optics Facility. Paranal, 2 August.

ELT secondary mirror blank cast by Schott, Mainz, Germany, 24 August.

ESO Workshop “Reaching New Heights in Astronomy: Celebrating ESO’s achievements and perspectives from 10 years of Tim de Zeeuw as Director General”. ESO Headquarters, 28–30 August.

September

Xavier Barcons starts as ESO Director General.

ESO/M. Zamani



On 1 September 2017, Xavier Barcons became ESO’s eighth Director General.

149th extraordinary FC meeting. ESO Headquarters, 19 September.

October

A press event was held to announce ESO’s involvement in the detection and characterisation of the visible counterpart to the gravitational wave source, GW170817 for the first time and detect the first kilonova. ESO Headquarters, 16 October.

Joint ESO/ESA Workshop 2017 “Working together in support of science”. European Space Astronomy Centre, Madrid, Spain, 17–20 October.

ESO Open House Day 2017 on Saturday 21 October, as part of a day of public access to the Garching research campus.

90th STC meeting. ESO Headquarters, 24–25 October.

ESO Workshop “Submillimetre/millimetre/centimetre QUESO 2017”. ESO Headquarters, 25–27 October.

ESO telescopes join effort to characterise the first interstellar asteroid to be detected.

November

150th FC meeting. ESO Headquarters, 6–7 November.

ALMA Board meeting. ALMA Santiago Central Office, 15–17 November

101st OPC meeting. Munich, 14–16 November.

December

145th Council meeting. ESO Headquarters, 6–7 December.

First light for ESPRESSO. Paranal Observatory, 6 December.

ESO/P. Horálek



ESO Open House Day 2017. The programme included live experiments (like the comet-making experiment in this photo), guided tours, an exhibition on the ESO observatories, talks from ESO scientists, and a live connection to the ESO observatories in Chile.





This picture was taken at the northern tip of the Salar de Atacama — the largest salt flat in Chile. The salt flat is home to two similar freshwater lagoons that lie very close together: the Ojos del Salar, which translates to “Eyes of the Salt Pan”.

Glossary of Acronyms

4LGSF	4 Laser Guide Star Facility (VLT)	CO	Carbon monoxide	GARD	Group for Advanced Receiver Development (Sweden)
4MOST	4-metre Multi-Object Spectroscopic Telescope (VISTA)	CONICA	High-resolution near-infrared camera (VLT, NACO)	GmbH	Gesellschaft mit beschränkter Haftung, German limited liability company
A&A	Journal, Astronomy & Astrophysics	CPDS	Cartridge Power Distribution System	GRAAL	GRound-layer Adaptive optics Assisted by Lasers (AOF)
A&ARv	Journal, Astronomy and Astrophysics Review	CRIRES	Cryogenic InfraRed Echelle Spectrometer (VLT)	GRAVITY	AO assisted, two-object, multiple beam-combiner (VLTi)
ADC	Atmospheric Dispersion Compensator	CRIRES+	Planned upgrade to CRIRES	GTO	Guaranteed Time Observing
AGN	Active Galactic Nucleus	CTA	Cherenkov Telescope Array	GuideCamTool	Unified target acquisition preparation tool for all ESO instruments
AJ	Journal, Astronomical Journal	DG	Director General	HARMONI	High Angular Resolution Monolithic Optical and Near-infrared Integral-field spectrograph (ELT)
ALMA	Atacama Large Millimeter/ submillimeter Array	DSC	Directorate for Science	HARPS	High Accuracy Radial velocity Planetary Searcher (3.6-metre)
AMBER	Astronomical Multi-BEam combineR (VLTi instrument)	DSM	Deformable secondary mirror	HAWK-I	High Acuity Wide field K-band Imager (VLT)
AN	Journal, Astronomische Nachrichten	EASC	European ALMA Support Centre	HIRES	Proposed ELT high-resolution spectrograph
Antu	VLT Unit Telescope 1	ELT	Extremely Large Telescope	HR	Human Resources
AOF	Adaptive Optics Facility	EFOSC2	ESO Faint Object Spectrograph and Camera 2 (NTT)	HST	NASA/ESA Hubble Space Telescope
AOS	Array Operations Site (ALMA)	EIROforum	Organisation consisting of the eight scientific European international organisations devoted to fostering mutual activities	IAC	Instituto de Astrofísica de Canarias
APEX	Atacama Pathfinder EXperiment	EMAC	ELT Management Advisory Committee	IAU	International Astronomical Union
AIV	Assembly, integration and verification process	EM&P	Journal, Earth, Moon, and Planets	Icar	Icarus, Journal, Planetary science
ApJ	Journal, Astrophysical Journal	ePOD	education and Public Outreach Department	IET	Integrated Engineering Team (ALMA)
ApJS	Journal, Astrophysical Journal Supplement Series	ERIS	Enhanced Resolution Imager and Spectrograph (VLT)	INAF	Italian National Institute for Astrophysics
ARA&A	Journal, Annual Reviews of Astronomy & Astrophysics	ERP	Enterprise Resource Planning	IPAG	Institut de Planétologie et d'Astrophysique de Grenoble
ARC	ALMA Regional Centre	ESA	European Space Agency	ISAAC	Infrared Spectrometer And Array Camera (VLT)
ArTéMiS	Architectures de bolometres pour des Télescopes a grand champ de vue dans le domaine sub-Millimetrique au Sol (APEX)	ESAC	European Science Advisory Committee (for ALMA)	IT	Information Technology
ARTIST	Adaptable Radiative Transfer Innovations for Submillimetre Telescopes	ESC	ELT Subcommittee	JAO	Joint ALMA Observatory
ASTRONET	EU scheme for astronomy cooperation and coordination at national or regional level in the Member States and Associated States	ESO	European Organisation for Astronomical Research in the Southern Hemisphere	JIRA	Proprietary issue tracking product
AT	Auxiliary Telescope for the VLTi	ESON	ESO Science Outreach Network	KMOS	K-band Multi-Object Spectrograph (VLT)
ATT	ALMA Technical Team	ESPRESSO	Echelle SPectrograph for Rocky Exoplanet and Stable Spectroscopic Observations (VLT)	Kueyen	VLT Unit Telescope 2
au	Astronomical unit (Earth–Sun distance)	ESRF	European Synchrotron Radiation Facility	LABOCA	Large APEX BOlometer CAmera
AUI	Association of Universities Inc.	EU	European Union	LEGA-C	Large Early Galaxy Census
BlackGEM	Telescope array searching for optical counterparts of gravitational wave sources	EWASS	European Week of Astronomy and Space Science	LFC	Laser Frequency Comb
CAD	computer-aided design	ExA	Journal, Experimental Astronomy	LGSF	Laser Guide Star Facility (VLT)
CASA	Common Astronomy Software Applications (ALMA)	ExTra	Exoplanets in Transits and their Atmospheres (hosted telescopes, La Silla)	LIGO	Laser Interferometer Gravitational-Wave Observatory
CCD	Charge Coupled Device	FDR	Final Design Review	LPO	La Silla Paranal Observatory
CERN	European Organization for Nuclear Research	FIAT	Facility for Infrared Array Testing	LSP	La Silla Paranal Subcommittee
CIAO	Coudé Infrared Adaptive Optics system (VLT)	FLAMES	Fibre Large Array Multi Element Spectrograph (VLT)	LTAO	Laser tomography adaptive optics
CMOS	Complementary metal oxide semiconductor	FORS2	FOcal Reducer/low dispersion Spectrograph 2 (VLT)	M#	Mirror #
		GALACSI	Ground Atmospheric Layer Adaptive optiCs for Spectroscopic Imaging (AOF)	MACAO	Multiple Application Curvature Adaptive Optics
				MAORY	Multi-conjugate Adaptive Optics Relay (ELT)

MASCARA	Multisite All Sky CAmeRA (La Silla)	OSO	Onsala Space Observatory	VANDELS	VIMOS spectroscopic survey in the UKIDSS Ultra Deep survey field and the Chandra Deep Field South (CANDELS fields)
MATISSE	Multi AperTure mid-Infrared SpectroScopic Experiment (VLT)	P#	Observing Period		
Melipal	VLT Unit Telescope 3	P&SS	Journal, Planetary and Space Science		
METIS	Mid-infrared ELT Imager and Spectrograph (ELT)	PAE	Provisional Acceptance Europe	VDL	Van Der Leegte Groep, the Netherlands
MICADO	Multi-AO Imaging CAmera for Deep Observations (ELT)	PASJ	Journal, Publications of the Astronomical Society of Japan	VIMOS	Visible Multi-Object Spectrograph (VLT)
MIDI	Mid-infrared Interferometric Instrument (VLT)	PASP	Journal, Publications of the Astronomical Society of the Pacific	VISIR	VLT Imager and Spectrometer for mid-InfraRed
MNRAS	Journal, Monthly Notices of the Royal Astronomical Society	PDR	Preliminary Design Review	VISTA	Visible and Infrared Survey Telescope for Astronomy
MOONS	Multi Object Optical and Near-infrared Spectrograph (VLT third generation)	PESSTO	Public ESO Spectroscopic Survey of Transient Objects	VLBI	Very Long Baseline Interferometry
MOS	Proposed multi-object spectrograph (ELT)	PFS	Pre-focal station (ELT)	VLT	Very Large Telescope
MOSAIC	Multi-object spectrograph (ELT)	PhysRevLett	Journal, Physical Review Letters	VLTi	Very Large Telescope Interferometer
MPE	Max Planck Institute for Extraterrestrial Physics	PI	Principal Investigator	vOT	Visitor Mode Observing Tool
MPG	Max-Planck-Gesellschaft	PI230	230 GHz receiver for APEX	VST	VLT Survey Telescope
MPIfR	Max Planck Institute for Radio Astronomy	PIONIER	Precision Integrated Optics Near-infrared Imaging Experiment (VLT)	VVVX	ESO Public Survey VISTA Variables in the Vía Láctea — extended
MUSE	Multi Unit Spectroscopic Explorer (VLT)	REM	Rapid Eye Mount telescope (La Silla)	WFI	Wide Field Imager (MPG/ESO 2.2metre telescope)
NACO	NAOS-CONICA (VLT)	SAESA	Chilean Electrical company	XFEL	European X-ray free-electron laser
NAOJ	National Astronomical Observatory of Japan	Science	Journal	XMM-Newton	X-ray Multi-Mirror satellite (ESA)
NAOMI	Adaptive optics system for the ATs (VLT)	SEPIA	Swedish ESO PI receiver for APEX	X-shooter	Wideband ultraviolet-infrared spectrograph (VLT)
NAOS	Nasmyth Adaptive Optics System (VLT)	SHFI	Swedish Heterodyne Facility Instrument	Yepun	VLT Unit Telescope 4
NASA	National Aeronautics and Space Administration	SINFONI	Spectrograph for INtegral Field Observations in the Near Infrared (VLT)	µm	Micrometre
Nature	Journal	SOFI	Son OF Isaac (NTT)		
NewA	Journal, New Astronomy	SOXS	Son Of X-Shooter (NTT)		
NewAR	Journal, New Astronomy Review	SPECULOOS	Search for habitable Planets EClipsing ULtra-cOOl Stars (Paranal)		
NGC	New General Catalogue	SPHERE	Spectro-Polarimetric High-contrast Exoplanet REsearch instrument (VLT)		
NGTS	Next-Generation Transit Survey (Paranal)	SPIFFI	SPectrometer for Infrared Faint Field Imaging (SINFONI, VLT)		
NIRPS	Near Infra Red Planet Searcher (3.6-metre)	STC	Scientific Technical Committee		
NIX	Infrared imager (VLT)	STEM	Science, Technology, Engineering and Mathematics		
NOVA	The Netherlands Research School for Astronomy (Nederlandse Onderzoekschool voor Astronomie)	STFC	UK Science and Technology Facilities Council		
NRAO	National Radio Astronomy Observatory	TAROT-S	Télescopes à Action Rapide pour les Objets Transitoires South (La Silla)		
NSF	National Science Foundation (US)	telbib	ESO Library telescope bibliography database		
NTT	New Technology Telescope (La Silla)	TRAPPIST	TRAnsiting Planets and PlanetesImals Small Telescope (La Silla)		
ODG	Office of the Director General	ULTRACAM	Highspeed camera (VLT UT3: P74–79; NTT: P85–87)		
OmegaCAM	Wide-field camera (VST)	UT	VLT Unit Telescopes 1–4: Antu, Kueyen, Melipal and Yepun		
OPC	Observing Programmes Committee	UVES	UltraViolet-Visual Echelle Spectrograph (VLT)		
OSF	ALMA Operations Support Facility				

ESO Europe

Headquarters
Karl-Schwarzschild-Straße 2
85748 Garching bei München
Germany
Phone +49 89 320 060
Fax +49 89 320 2362
information@eso.org
www.eso.org

ESO Chile

ESO Vitacura
Alonso de Córdova 3107
Vitacura
Casilla 19001
Santiago de Chile
Chile
Phone +56 2 2463 3000
Fax +56 2 2463 3101

La Silla Paranal Observatory
La Silla Site
IV Región
Chile
Phone +56 2 2464 4100
Fax +56 2 2464 4101

La Silla Paranal Observatory
Paranal Site
II Región
Chile
Phone +56 55 2435 100
Fax +56 55 2435 101

APEX Séquitor Base
Ayullo de Séquitor, Parcela 85
San Pedro de Atacama
II Región
Chile
Phone +56 55 2448 200 Ext. 448
Fax +56 55 2448 221

APEX Chajnantor Site
II Región
Chile
Phone +56 55 2448 299

ESO La Serena Office
Avenida Panorámica No. 4461
Sector Aeroparque La Florida
Casilla 567
La Serena
Chile
Phone +56 51 2272 601
Fax +56 51 215 175

Guesthouse
Rey Gustavo Adolfo No. 4634
Las Condes
Santiago
Chile
Phone +56 2 2208 4254
Fax +56 2 2228 9333

ESO Antofagasta Office
Avenida Balmaceda 2536
Office 504
Edificio "Don Guillermo"
Antofagasta
Chile
Phone +56 55 2260 032
Fax +56 55 2260 081

ESO is a partner in the international
ALMA project

ALMA Santiago Central Offices
Alonso de Córdova 3107
Vitacura
Casilla 763 0355
Santiago
Chile
Phone +56 2 2467 6100
Fax +56 2 2467 6101

ALMA Operations Support Facility
Kilómetro 121
Carretera CH 23
San Pedro de Atacama
Chile
Phone +56 2 2467 6416

ALMA Array Operations Site
II Región
Chile

Cover: These four lasers form a key part of the Adaptive Optics Facility on the Very Large Telescope, which is designed to correct for the effects of atmospheric turbulence. Each of these powerful lasers creates a synthetic star by illuminating sodium atoms located at an altitude of over 90 km. The Adaptive Optics Facility was commissioned in 2016 and 2017 and is already producing stunning observations of a range of astronomical objects, ranging from planetary nebulae to galaxy clusters.
Credit: ESO/G. Hudepohl (atacamaphoto.com)

All images are courtesy of ESO unless otherwise indicated.

Edited by the Office of the Director General.

Produced by the education and Public Outreach Department.

ESO 2018
ISSN 0531-4496
DOI: 10.18727/docs/2

